

INSTRUCTION MANUAL PRESSURE-AND LEVEL TRANSMITTER

WARNING

Read this manual before working with the product. For personal and system safety and for optimum product performance. Make sure you thoroughly understand the contents before installing, using or maintaining the SERIES 2000-VALVE-RANGE.

SERIES 2000-VALVE-RANGE



Manufactured by:

 **KLAY-INSTRUMENTS B.V.**
www.klay-instruments.com

Nijverheidsweg 5
P.O. Box 13
Tel: +31-521-591550
Fax: +31 -521-592046

7991 CZ DWINGELOO
7990 AA DWINGELOO
The Netherlands
E-mail: info@klay.nl

<u>CONTENTS</u>		
SECTION		PAGE
1	Introduction	3
1.1	Description Series 2000-VALVE-RANGE	3
1.2	Barometric reference	3
2	Dimensional drawings	4
2.1	Parts description 1" model	4
2.2	Parts description 1,5" model	4
2.3	Before Welding	4
3	Welding & Installing transmitter	5
3.1	Installing transmitter	6
3.2	Mounting position	6
3.3	Mounting position effect	6
3.4	Calibration	6
3.5	Wiring	6
4	Remaining	7
4.1	Digital local indicator	7
4.2	CE / EMC - Rules	7
4.3	External load	7
4.4	Traceability year of manufacturing	7
4.5	Software Revisions	7
5	Functions of push buttons	8
6	Programming points (P101-P114)	9
7	Reading on the display	9
8	Explanation programming points P101 to P116	10
	P101 Zero adjustment (4 mA)	10
	P102 Span adjustment (20 mA) without test pressure	10
	P103 Cancel mounting position effect	11
	P104 Adjustment pressure unit on display	11
	P105 Reverse output (20-4 mA)	12
	P106 Adjustment damping (0 till 25 sec)	12
	P107 Indication of process temperature	12
	P108 Temperature in °C of °F	12
	P109 Read out on display	12
	P110 Simulation of current	13
	P111 Linearization	14/15
	P112 Specific density	16
	P113 Write protection	16
	P114 Response time from push buttons	16
	P115 Service-menu	16
	P116 Service-menu	16
9	Programming of the series 2000-VALVE	17
9.1	Programming the hand held terminal	17
9.2	Programming with DTM	17
9.3	Programming with PDA	17
10	Precautions and warnings	18

1 INTRODUCTION

1.1 DESCRIPTION SERIES 2000-VALVE-RANGE

The Series 2000-VALVE-RANGE is a **unique** combination of the series 2000 and ball Valve. The Series 2000-VALVE-RANGE is specially designed for the pulp- and paper industry or similar, where clogging is a problem. The very compact construction of the series 2000-VALVE-RANGE permits flush installation with the tank- or pipe wall. The transmitter part can be removed without shutting down the process (for example: during cleaning or maintaining activities). The diaphragm (21) is flush with the tank/pipe when the transmitter is pushed through the valve and locked in its measuring position. All wetted parts are made of SS 316 (AISI).

1.2 BAROMETRIC REFERENCE

The SERIES 2000-VALVE are in basic so-called "relative transmitter" which means that barometric changes will not affect the zero (4 mA). The venting (4) is placed at the side of the electronic housing and is the barometric reference to atmospheric. The venting must be kept clean.

2. DIMENSIONAL DRAWING

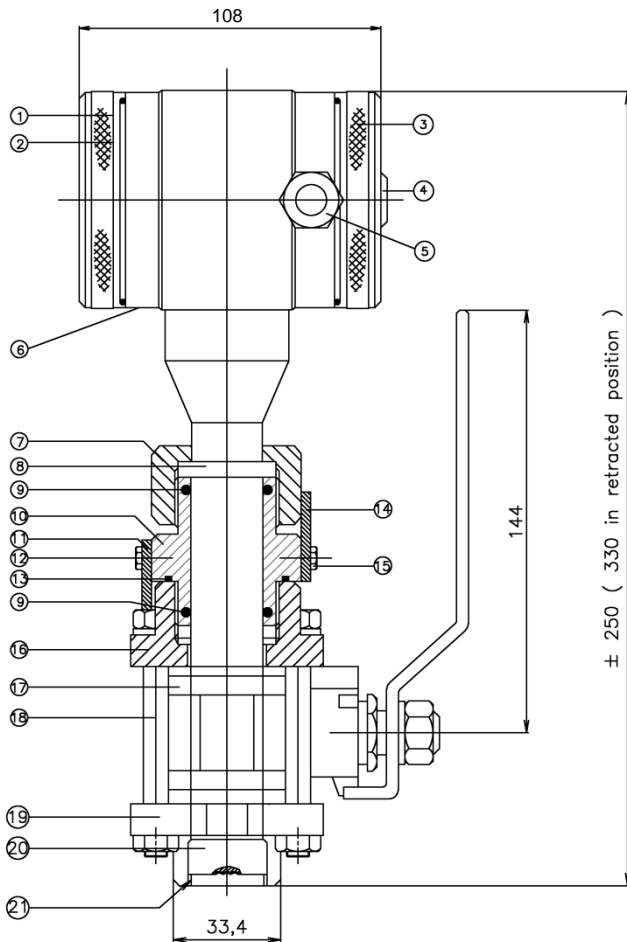

2.1 PARTS DESCRIPTION (1")

1. Cover	AISI 304
2. Push buttons + display (behind cover)	
3. Cover with venting	AISI 304
4. Venting	PA
5. PG9 cable gland	
6. Electronics housing	AISI 304
7. Hexagon nut, SW 41	AISI 304
8. Stop	AISI 316
9. O-ring (2x)	VITON
10. Nipple, SW 41 (1" BSP M 2x)	AISI 316
11. Safety Lock	AISI 304
12. M4 Bolt	AISI 304
13. O-ring	VITON
14. Safety Lock	AISI 316
15. M4 Bolt (2x)	AISI 304
16. Threaded valve joint (1" BSP F)	AISI 316
17. Valve body	AISI 316
18. M8 Valve Bolt (4x)	AISI 316
19. Weld on Nipple diam. 33,4 mm	AISI 316
20. Foot with diaphragm	AISI 316L
21. Diaphragm Protection	AISI 316

2.2 PARTS DESCRIPTION (1 1/2")

	MATERIAL
7. Hexagon nut, SW 60	AISI 304
10. Nipple, SW 57 (1 1/2" BSP M 2x)	AISI 316
16. Threaded valve joint (1 1/2" BSP F)	AISI 316
18. M 10 Valve bolt (4x)	AISI 316
19. Welded spud (outside Ø 48,5 mm)	AISI 316

For welding and installing the 2000-VALVE-RANGE read the next page (5) very carefully and follow exactly the instructions.

2.3 BEFORE WELDING

1. Unlock the safety lock (14).
2. Unscrew nut (7)
3. Retract transmitter until it does not want any further
4. Unlock the safety lock(11).
5. Unscrew nut (10) from threaded valve joint (16).
6. Retract transmitter from valve
7. Protect diaphragm (21) very carefully



BEFORE OPENING THE VALVE, MAKE SURE THAT THE TRANSMITTER IS LOCKED.

3. WELDING AND INSTALLING TRANSMITTER

For welding and installing the Series 2000-VALVE-RANGE the instructions on the next page must be followed exactly. This is extremely important to ensure a good working of the system.

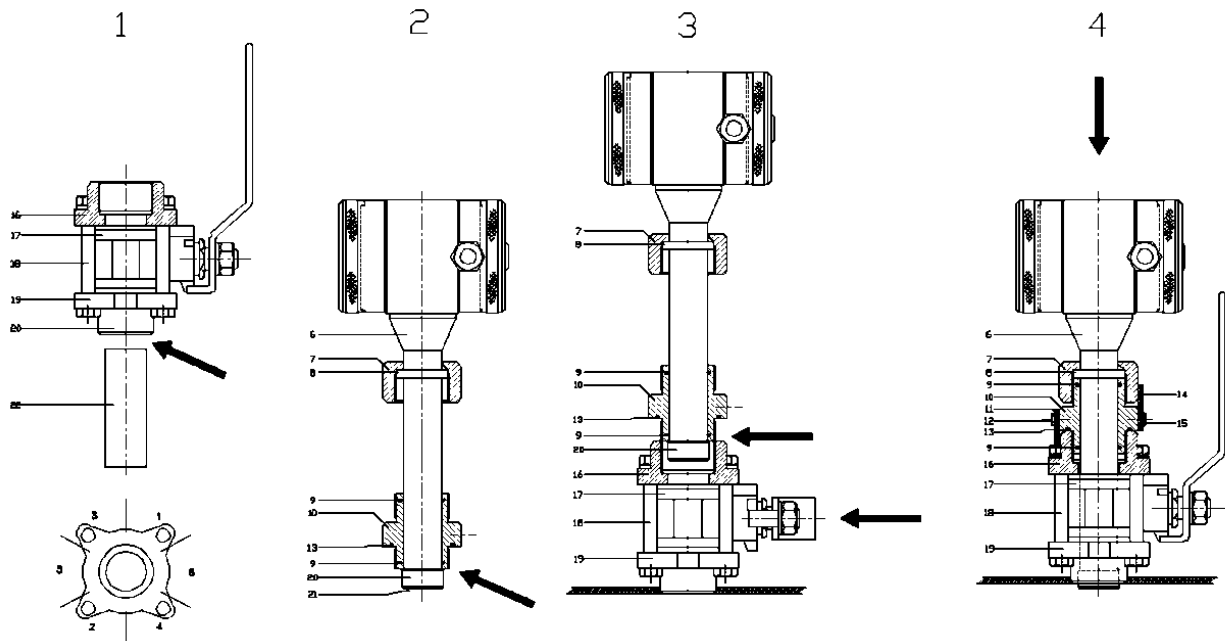

Warning:

Improper installation may result in weld spud distortion

A. Installation weld on nipple (figure 1):

1. Remove the weld spud (19) from the valve by unscrewing the four bolts (18).
2. Cut a hole in the process vessel/pipe to accept the weld spud. The hole should produce a tight fit when coupled with the weld spud.
3. Prepare the vessel hole bevelling the edge to accept filler material.
4. Position the weld spud in the vessel hole and tack six places. The weld sequence is shown in figure 1.

WARNING

Excessive heat will distort the weld spud (19). Weld in sections as shown in Figure 1. allow adequate cooling between passes. To reduce the chances of distortion to the weld spud, use a heat sink (22).

B. Installation Valve

1. Mount valve on the weld spud by using the auxiliary tool to ensure the parts are in-line. Use silicone grease.
2. Tighten the valve bolts (18) (4x)
3. Remove the auxiliary tool and make sure the valve and be closed and opened easily.
4. Make sure the valve is **CLOSED**.

Warning:

DO NOT DAMAGE THE DIAPHRAGM.

C. Installation transmitter (figure 2)

1. Remove the nipple (10) to the bottom of the transmitter part as shown in figure 2. Use silicone oil or grease.
2. Make sure the O-ring (13) is properly located.

D. Figure 3

1. Make sure to correctly locate the O-ring (13) into the nipple
2. Position the transmitter into the threaded valve joint and begin engaging the threads. The transmitter can be rotated prior to seating enabling the user to optimize access to calibration adjustments, cable entry and local indicator.
3. Tighten the nipple (10).t.
4. Lock the nipple (10) to the threaded valve joint (16) by means of the safety lock (11) and two M4 bolts(12).
5. Valve must be opened (90°) **VERY** slowly.

E. Figure 4

1. Transmitter must be pushed through the valve until hexagon nut (7) reaches the nipple (10).
2. Begin engaging the threads until stop (8) reaches nipple (10).
3. Tighten hexagon nut (7).
4. Lock the nut (7) to the nipple (10) by means of the safety lock (14) and two M4 bolts (15)

WARNING: BEFORE OPENING THE VALVE, MAKE SURE THE TRANSMITTER IS LOCKED. BE SURE THE VALVE IS CLOSED WHEN HE TRANSMITTER IS RETRACTED FROM VALVE. THIS IS EXTREMELY IMPORTANT OTHERWISE THE TRANSMITTER WILL PUSH OUT OF THE PROCESS.

3.1 INSTALLING TRANSMITTER SERIES 2000-VALVE-RANGE

The position of the valve depends on the welding position of the weld-on nipple. Before welding, locate weld-on nipple so that the valve is in the right position.

 **DO NOT DAMAGE THE THREAD.**

3.2 MOUNTING POSITION

When the transmitter is mounted horizontally, the cable gland MUST be pointed downwards.

3.3 MOUNTING POSITION EFFECT

All transmitters are calibrated in vertical position.

If the transmitter is mounted in a different position, there will be a little zero shift.

If the transmitter is mounted up, there is a zero shift (e.g. 4,03 mA instead of 4mA). If the transmitter is mounted down, there is a zero shift (e.g. 3.97 mA instead of 4mA).

After installation of the transmitter the zero must be set to 4.00 mA with "P103" in the programming mode. This will not affect the span.

3.4 CALIBRATION

All transmitters are fully calibrated at the factory, to the conditions stipulated in users order. When the buyer has not requested calibration, the transmitter will be calibrated at the highest span. It is advised to re-calibrate the transmitter after shipment.

3.5 WIRING

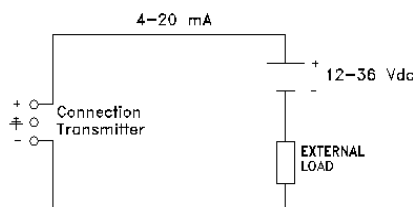

Under the cover (3) you will find the terminal board. The push buttons "Zero", "Span" and "Prog" are under the other cover (1).

External loads must be placed in the negative leg of the 2-wire loop.

The figure left shows the wiring connection of the transmitter. The 2-wires must be connected to 3(-) and 4 (+) of the terminal board.

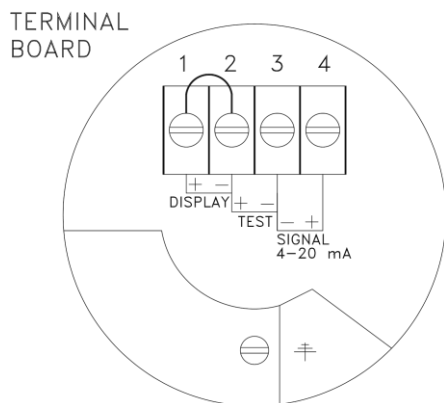

The transmitter must always be connected to earth.

The transmitter must be connected with standard two-wire shielded cable. **Do NOT** run signal wiring in open trays with power wiring, or near "heavy" electrical equipment (E.g.: Frequency controller or heavy pumps).

Shielding must always be connected at the side of the power supply. In case the process connection is already connected to ground (e.g. via the tank or pipe line) **DO NOT** connect the instrument to ground. Please ensure that the instrument is not connected to ground twice to prevent an 'earth loop'. In applications with synthetic process connections, the enclosure (internal or external) must be connected to ground.

4. REMAINING

4.1 DIGITAL LOCAL INDICATOR

All transmitters from the Series 2000-VALVE-RANGE are standard equipped with a digital display. In the standard execution the covers are "closed". The three push buttons and the display are behind the cover (3).

As an option an "open" cover can be delivered to achieve the display can be used as a local display in the process. The full-scale point may be set to any value between 0000 and 9999 (4 digit). (Option: "I" extra price).

4.2 CE / EMC - RULES

All Klay transmitters are manufactured in accordance with the RFI / EMC directives and comply with the CE standard. All transmitters are fitted with RFI filters, which provide optimum, trouble-free operation. Our products are in conformity with EMC-Directive 2014/30/EU based on test results using harmonized standards.

4.3 EXTERNAL LOAD

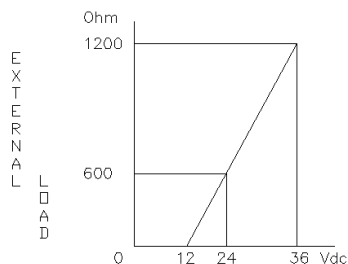

The minimum power supply is based on the total circuit resistance. The maximum permissible load (Ri max.) in case of 24 Vdc is 600 Ω (Ohm).

By increasing the power supply, the external load can be increased to 1200 Ohm / 36 Vdc. (see figure left).

$$Ri \text{ max.} = \frac{\text{Power Supply} - 12 \text{ Vdc}}{20 \text{ mA}}$$

20 mA



With a loop resistance of 250 Ω a power supply of at least 17 Vdc must be used.

4.4 TRACEABILITY YEAR OF MANUFACTURING

The year of manufacturing of the transmitter can be traced as follows: take the first two numbers from the serial number that is engraved in the transmitter and add 1970 to it.

For example: if the serial number is 4309036. The year of manufacturing is 1970 + 43 = 2013.

4.5 SOFTWARE REVISIONS

Due to the improvements on the Series 2000, there are several software versions (revisions). For this reason it is possible the transmitter you are working with does not support some options, which are discussed in this manual. This instruction is applicable from software revision V9.17. After powering up, the transmitter will show the revision number on the display.

5 FUNCTIONS OF PUSH BUTTONS

The Series 2000-VALVE-RANGE can be programmed easily by use of the 3 front panel pushbuttons (See picture right).

The display can show engineering units of: mH₂O, inH₂O, bar and PSI.

The functions of the three pushbuttons will be explained below.

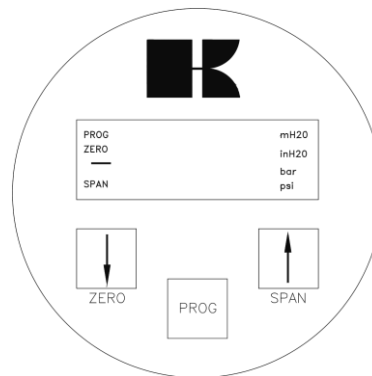

This button has 2 functions:

1. It can be directly used for adjusting the zero (zero / 4mA), with or without a test pressure. When the zero (4 mA) must be adjusted at 0 (atmospheric pressure), the button must be held until the word "ZERO" appears on the display. The transmitter is now set to 4 mA.
2. Also, this button must be used for stepping down in the programming menu or to decrease a value (-).

Note: For canceling the mounting position effect you have to use P103.



This button has 2 functions:

1. It can be directly used for adjusting the span (20 mA), when using a test pressure (air). When a test pressure (e.g. 2 bar) is supplied to the transmitter, the button must be held until the word "SPAN" appears on the display. The transmitter is adjusted at 20 mA now. The span can also be adjusted without test pressure (see P102).
2. Also, this button must be used for stepping up in the programming or to increase a value (+).



This button has 2 functions:

1. It is used to adjust the 14 Programming Points (P101 to P114). Push it once and P100 is displayed, use the [↑] (SPAN) to step to P101 etc.
2. This button must also be used for confirming the adjustments (enter).

For example if you want to change the adjustment in bars (P104), the following steps must be taken:

1. Push on [PROG] till "100" appears on the display.
2. Push on [SPAN] 4 times to go to point "P104" (adjustment pressure unit).
3. Push [PROG] to confirm this.
4. Push several times on [↑] (SPAN) to reach 3 (= bar). See also the conversion table (page 11).
1 = mWc, 3 = bar, 5 = PSI, 11 = inch WC
5. Confirm this by pushing once at [PROG].
The transmitter is now adjusted to read in "bar".

6. PROGRAMMING POINTS (P101 – P116)

The following points can be adjusted by means of the three push buttons.
For an explanation of these points see page 10 to 16 of this manual.

To change one of these points you have to push on [PROG] until "100" appears on the display.
To go to from a lower program (P101) to a higher one (P102), push on button [↑] (SPAN).

To confirm the adjustments you always have to press on [PROG].

*) Standard adjustments ex works.

Programming points:	
P101	Zero adjustment (4 mA)
P102	Span adjustment (20 mA)
P103	Cancel mounting position effect
P104	Adjustment pressure unit (See Conversion table)
P105	4-20 mA *) 20-4 mA (Reverse output)
P106	Adjustment damping (0 to 25 sec)
P107	Indication of process temp. (Read out on display)
P108	0 = °C (*) 1 = °F
P109	Read out on display: Curr (0) = current (4 - 20 mA) (*) Unit (1) = pressure unit (conversion table) PerC (2) = percentages TenP (3) = temperature Hect (4) = hectoliters CB n (5) = Cubic meters Ltr (6) = Liters
P110	Simulation of current
P111	Linearization 0 = no Linearization (*) 1 = cylindrical tank 2 = vertical tank with cone 3 = vertical tank with spherical cone
P112	Specific density
P113	Write Protection
P114	Response time from push buttons
P115	Service-menu
P116	Service-menu

7. READING ON THE DISPLAY

On the standard built-in display several values can be shown.

During the programming of the transmitter the display shows all the information that is needed.
When the transmitter is in the process the display gives all the information of the process pressure or temperature.

On the display the following units can be showed: mH₂O, inH₂O, bar and PSI (see also P104 and P109).

PROG	mH20
ZERO	inH20
—	bar
SPAN	psi

N.B.: The standard transmitter is supplied with two "closed" covers shielding the buttons and the display. As an option an "open" cover (IP 65) can be fitted. The display can then be used as a local process display. (Option: "I" extra price). The full scale can be set between -9999 and 9999 (4 digit).

8. EXPLANATION PROGRAMMING POINTS P101 to P116

P101

ZERO ADJUSTMENT (4 mA)

The transmitter as standard is adjusted to 4.00 mA at atmospheric pressure. It is also possible to adjust a zero-suppression or elevation.

For example: zero elevation of 1 mWc.

1. Push at [PROG] until "100" is shown on the display.
2. Push once at [↑] / SPAN till "101".
3. Confirm this by pushing [PROG].
4. Now the display will show 0.00 mH₂O. Push at [↑] till 1.00 mH₂O is on the display.
5. Confirm with [PROG].
6. The output of the transmitter will be lower than 4 mA. The output at atmospheric pressure will be for example 3.68 mA.
When a pressure of 1 mWc is applied on the diaphragm the output will be 4.00 mA.

The elevation can be canceled by pushing at [ZERO] till zero disappears out of the display. The transmitter is now adjusted at 4 mA at atmospheric pressure.

P102

SPAN ADJUSTMENT (20 mA) WITHOUT TEST PRESSURE

Before adjusting the span take care the right pressure unit is selected. (See also P104).

Example: Adjustment of the span at 0 - 2 bar.

First off all, the pressure unit must be adjusted at "bar". (See P104 and P109).

1. Push [PROG] till "100" is shown on the display.
2. Push twice at [↑] / SPAN until "102" is on the display.
3. Confirm this by pushing [PROG].
4. Push [SPAN] (+) or [ZERO] (-) to select the measuring range that is required.
5. Confirm by pushing [PROG].
The transmitter is adjusted now.

N.B.: P102 is the adjustment of the total span.

When a "compound" range must be adjusted (for example -1 till +3 bar), a span of 4 bar must be programmed. At P101 (ZERO,4 mA), -1 bar must be adjusted. Now the transmitter is adjusted at: - 1 bar = 4 mA and +3 bar = 20 mA.

N.B.:

It is not possible to show values larger than '9999' or smaller than '-9999' on the display. In this case the display will show:

---- For values larger than '9999'.

.... For values smaller than '-9999'.

As long as the display shows "- - - -", the value will not be saved by pressing "PROG".

P103

CANCEL MOUNTING POSITION EFFECT

All transmitters are calibrated vertically. When a transmitter of the Series 2000-VALVE-RANGE is installed horizontally, there will be a small "mounting effect" on the zero (4 mA). For example the transmitter shows 4.03 mA instead of 4.00 mA. This can be easily canceled with P103. In P103 there are three options:

1. **ESC:**
Nothing can be changed.
Leave without doing anything. (confirm with PROG).
2. **RESET:**
Use this option when you are not sure if P103/SET has been done in a proper way. (confirm with PROG).
when using this option the original factory setting will be valid.
3. **SET:**
Canceling mounting position effect. (confirm with PROG).
When "SET" is selected the transmitter is automatically adjusted at 4.00 mA. The span will not be affected.

CAUTION: Do not apply pressure while executing "cancel mounting position effect"

N.B.:

From revision 2 the description above is valid. Transmitters working with software revision 1 will direct process cancel mounting position.

P104

ADJUSTMENT PRESSURE UNIT ON DISPLAY (See Conversion table)

Several engineering units can be shown on the display by using a conversion factor. (See conversion table below). Four engineering units will light up on the display (mH₂O, inH₂O, bar and PSI).

N.B.: To show one of the engineering units, P109 must be adjusted at 1 (= pressure unit).

This will be explained with an example (e.g. bar):

1. Push at [PROG] till "100" is shown on the display.
 2. Push 4 times at [↑], go to [P104].
 3. Push at [PROG] to confirm this.
 4. Push at [↑] / [SPAN] and adjust at 3 (= bar).
1 = mH₂O (=mWc), 3 = bar, 5 = PSI, 11 = inch WC.
 5. Confirm with [PROG].
- The transmitter will now read out in bars.

CONVERSION TABLE:

104	CONVERSION FACTOR	DISPLAY
1	1.000	mH ₂ O (mWc) *
2	1000	m H ₂ O (mm WC)
3	0.09806	bar *
4	98.0665	mbar
5	1.4223	PSI *
6	0.0967	Atm
7	9.80665	KPa
8	0.009807	MPa
9	0.1	Kgf/cm ²
10	73.556	mm HG
11	39.37	inH ₂ O ("WC) *
12	2.895906	"HG

*) Pressure units that can be shown on the display. When the value of the highest range is larger than 9999, "NA" will appear in the display (Not Applicable). Another unit must be chosen.

P105 **REVERSE OUTPUT (20 - 4 mA)**

The transmitter as standard is adjusted to 4-20 mA.
 Push on [PROG] and go to P105.
 Push once at [↑] to change the output to 20-4 mA (Reverse output).
 Push at [PROG] to confirm this.
 Now the transmitter will give 20 mA at atmospheric pressure.

P106 **ADJUSTMENT DAMPING (0 till 25 sec)**

In P106 an electronic damping can be adjusted between 0 and 25 seconds.
 This can be done with the push buttons [↑] (up) and [↓] (down).
 Always confirm by pushing once at [PROG].

P107 **INDICATION OF PROCESS TEMPERATURE (READ OUT ON DISPLAY)**

1. Push [PROG] until "100" is shown on the display.
2. Push 7 times at [↑], go to [P107].
3. Push [PROG] to confirm this. Now the process temperature appears on the display (Indication: +/-2°C).

This will remain on the display. To get the actual pressure back on the display you have to push again on P107 until the actual pressure appears on the display again.

P108 **TEMPERATURE IN °C OR °F**

The temperature of the transmitter is standard adjusted at °C ("DEGR"). When pushing at [↑] in P108, this will change into °F ("FAHR").
 Always confirm by pushing once at [PROG].

P109 **READ OUT ON DISPLAY**

Curr (0) = current (4 - 20 mA)
 Unit (1) = pressure unit (See conversion table)
 PErC (2) = percentages (0 - 100%)
 TEnP (3) = temperature (°C of °F)
 HECt (4) = hectoliter (only in combination with P111)
 Cb n (5) = Cubic meter (only in combination with P111)
 Ltr (6) = Liters (only in combination with P111)

As standard the transmitter is delivered with read out in mA (0). To change this, follow the next steps:

1. Push [PROG] until "100" is shown on the display.
2. Push 9 times at [↑] / SPAN till "109" appears on the display.
3. Confirm with [PROG].
4. Push once at [↑].
5. Push [PROG] to confirm this.
 The transmitter will now read mH₂O (mWc).

The pressure unit can be changed with the conversion table in "P104".
 1 = mH₂O (=mWc), 3 = bar, 5 = PSI, 11 = inch WK.

Also the read out can be 0 - 100%. In this case select "P109", option 2.

P110

SIMULATION OF CURRENT (4-20 mA)

The transmitter can be used as a simulator of a current between 4 - 20 mA.
This can be done in P110 with the push buttons [↑] and [↓].

The user can perform a current simulation (Curr) or a pressure simulation (Unit).

Current-simulation (Curr)

To perform a current-simulation follow the next steps:

1. Push [PROG] until "100" is shown on the display.
2. Push 10 times at [↑] / SPAN till "110" appears on the display.
3. Confirm with [PROG].
4. The display will readout 'Curr'
5. Confirm with [PROG].
6. The display shows '4.00'. Push [PROG] and the output changes to 4.00 mA.
7. By pushing [↑] / SPAN or [↓] / ZERO, you can change the value on the display.
The output value will change as soon as the [↑] / SPAN OR [↓] / ZERO button is released.
8. Pressing the [PROG]-button again will exit the simulation.

Pressure-simulation (Unit)

To perform a pressure-simulation follow the next steps:

1. Push [PROG] until "100" is shown on the display.
2. Push 10 times at [↑] / SPAN till "110" appears on the display.
3. Confirm with [PROG].
4. The display will readout 'Curr'
5. Press [↑] / SPAN once
6. The display will readout 'Unit'.
7. Confirm with [PROG].
8. The display shows a pressure value. Push [PROG] and the output changes to a mA-output corresponding with the range entered in menu P101 and P102.
9. By pushing [↑] / SPAN or [↓] / ZERO, you can change the value on the display.
The output value will change as soon as the [↑] / SPAN OR [↓] / ZERO button is released.
10. Pressing the [PROG]-button again will exit the simulation.

Note:

- The values that can be entered using the pressure-simulation are related to the adjustments in menu P101 and P102. These values are also the minimum and maximum values.
- For HART-transmitters: this menu will not work when the device is operating in multi-drop mode.

P111

LINEARIZATION

- 0 = no linearization
- 1 = cylindrical tank (horizontal)
- 2 = tank with bottom cone
- 3 = tank with spherical bottom

As standard the transmitter is delivered without linearization (= 0). However, for a horizontal tank or a tank with a bottom cone, a linearization can be applied to achieve the current signal (mA) is equal to the level in the tank. All values must be programmed in meters.

Linearization horizontal tank (Cilindric)

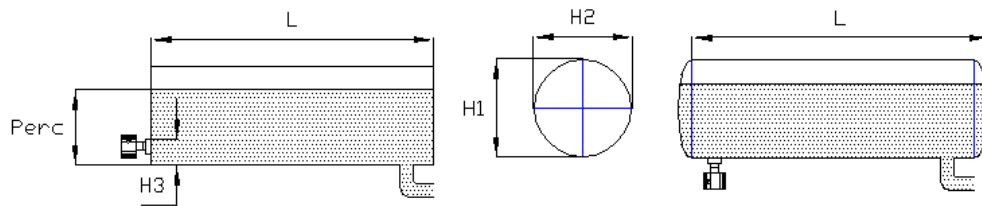

Cylindrical horizontal tank

Cylindrical tank with cone-shaped ends

1. Push [PROG] until "100" is shown on the display.
2. Push 11 x at [↑] / SPAN till "111" appears. (Confirm with [PROG])
3. Push [↑] once. (Confirm with [PROG])
4. Enter the height (H1) of the tank in meters. (Confirm with [PROG])
5. Enter the same height (H2) of the tank in meters. (Confirm with [PROG])
6. Enter the length (L) of the tank. For a "ball" or cone shaped tank, take the cylindrical

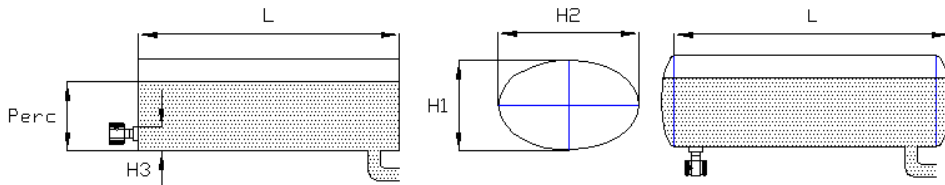

- length plus the length of 1 "ball" cone. (Confirm with [PROG])
7. Enter H3 in meters if the transmitter is installed like in the left picture. Enter 0m when the transmitter is installed like in the right picture.
8. Enter the percentage of the actual "full" level (for example 80%). (Confirm with [PROG]).

Linearization horizontal tank (Elliptic)

Cylindrical horizontal tank

Cylindrical tank with cone-shaped ends

1. Push [PROG] until "100" is shown on the display.
2. Push 11 x at [↑] / SPAN till "111" appears. (Confirm with [PROG])
3. Push [↑] once. (Confirm with [PROG])
4. Enter the height (H1) of the tank in meters. (Confirm with [PROG])
5. Enter the height (H2) of the tank in meters. (Confirm with [PROG])
6. Enter the length (L) of the tank. For a "ball" or cone shaped tank, take the cylindrical length plus the length of 1 "ball" cone. (Confirm with [PROG])
7. Enter H3 in meters if the transmitter is installed like in the left picture. Enter 0m when the transmitter is installed like in the right picture.
8. Enter the percentage of the actual "full" level (for example 80%). (Confirm with [PROG]).

Note

If the height (H) of the tank is 1 meter and the maximum level in the tank is 0,8 meter the percentage (point 5) must be set at 80%. **The calibration at P102 must be adjusted at: 1 meter (if s.g. equals 1).**

Linearization vertical tank with cone

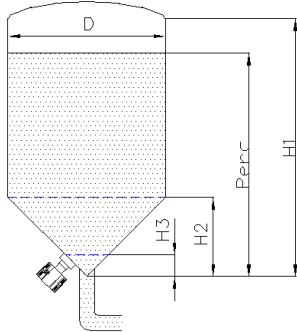

1. Push [PROG] till "100" appears on the display.
2. Push 11 times at [↑] till "111" appears. (Confirm with [PROG])
3. Push twice at [↑]. (Confirm with [PROG])
4. Enter height (H1) of the tank (= actual level).(Confirm with [PROG]).
5. Enter diameter (D) of tank. (Confirm with [PROG])
6. Enter height (H2) of cone. (Confirm with [PROG])
7. Enter the height (H3) from the bottom of the tank to the topside of the diaphragm (or weld-on nipple). (Confirm with [PROG]).
8. Enter the percentage of the actual "full" level (for example 80%).(Confirm with [PROG]).

Linearization vertical tank with spherical cone (from software revision 3)

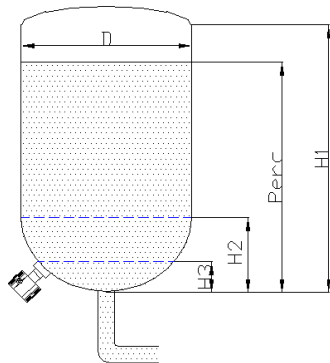

1. Push [PROG] till "100" appears on the display.
2. Push 11 times at [↑] till "111" appears. (Confirm with [PROG])
3. Push three times at [↑]. (Confirm with [PROG])
4. Enter height (H1) of the tank (= actual level).(Confirm with [PROG]).
5. Enter diameter (D) of tank. (Confirm with [PROG])
6. Enter height (H2) of cone. (Confirm with [PROG])
7. Enter the height (H3) from the bottom of the tank to the topside of the diaphragm (or weld-on nipple). (Confirm with [PROG]).
8. Enter the percentage of the actual "full" level (for example 80%).(Confirm with [PROG]).

Note

When the specific gravity of the fluid is unequal to 1 and you do not want to use option 4, you must take care of it by defining the **calibration** of the transmitter.
 Calibration (see P102) = Height of the level x Specific Gravity.

P112**SPECIFIC DENSITY**

If the specific gravity of the medium differs from 1 kg/dm³, you can enter the real density of the medium in P112. When this option is used, in menu P102, the 'true' height of the tank must be entered.

P113**WRITE PROTECTION**

The Series 2000-VALVE-RANGE with HART-Protocol can be protected for writing (Write Protection). This is possible for two kinds of writings:

- Changes via the Display ("Lo.Pr" = Local Protection).
- Changes via external HART configuration software by the **Hand-held terminal or the P.C.** ("Co.Pr."= Communication Protection).

Standard, the transmitter is set to no-write protection.

Adjustment Local Protection

1. Push [PROG] till "100" appears on the display.
2. Push [↑] / SPAN 13 times till "113" appears on the display.
3. Push [PROG] to confirm. ("Lo.Pr." appears on the display).
4. Push [↑]/[↓] for adjusting to "ON" or "OFF".
5. Push [PROG] to confirm.

Adjustment Communication Protection

1. Push [PROG] till "100" appears on the display.
2. Push [↑] / SPAN 13 times till "113" appears on the display.
3. Push [PROG] to confirm. ("Lo.Pr." appears on the display).
4. Push once more at [PROG]. ("Co.Pr." appears on the display).
5. Push [↑]/[↓] for adjusting to "ON" or "OFF".
6. Push [PROG] to confirm.

N.B. When Lo.Pr. is set to "ON", the display shows 104, 105, 107, 108, 109 and 111 and the adjusted values of the parameters. Afterwards "PROT" (Protected) is shown.

Both protections can be adjusted at the same time, independent from each other.

P114**RESPONSE TIME FROM PUSH BUTTONS**

This option can only be used from software version 8.01. The response time from the push buttons can be adjusted from 0,0 till 5,0 seconds.

P115**SERVICE MENU**

Use only under order of manufacturer.

P116**SERVICE MENU**

Use only under order of manufacturer.

9. PROGRAMMING THE SERIES 2000-VALVE-RANGE



When using HART[®] or a Hand Held Terminal (HHT), a minimum resistance of 250 ohms **must** be present in the loop of the 2-wire system. This is necessary for proper communication (see drawing below). A power supply of at least **17 Vdc** must be used.

9.1 PROGRAMMING WITH THE HAND HELD TERMINAL

The series 2000-VALVE-RANGE can be programmed very easily with the Hand Held Terminal (HHT) from the HART[®] Foundation or the HHT from "Rosemount" (type 275 Hart Communicator). The HART[®] (Highway Addressable Remote Transducer) Communicator provides a common communication link to all HART[®] compatible, microprocessor-based instruments.

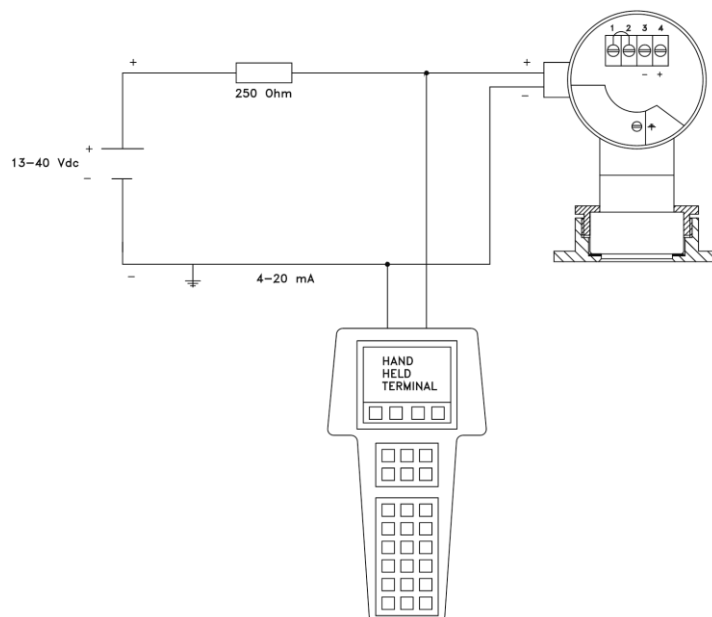

9.2 PROGRAMMING WITH DTM

There is an instruction manual available which is a guide for installing and using the Klay Series 2000 HART DTM. This DTM is developed to make configuration changes of Klay Series 2000 HART transmitters easy. This DTM can be used with almost every FDT-container. The most recent version of the DTM file (zip file) is available on: www.klay-instruments.com under section "Downloads". Unzip **DTM Klay Series 2000 HART V1-2-0-1.zip** and run **DTM Klay Series 2000 HART V1-2-0-1.exe**.

9.3 PROGRAMMING WITH PDM

There is also a Device Description (DD) available for the Series 2000 HART. This DD can be used for configuring a Series 2000 HART transmitter using Simatic PDM. The most recent version of the DD file (zip file) is available on: www.klay-instruments.com under section "Downloads". Unzip **KLAY_PDM_HART_REV8.zip** and run DeviceInstall.exe.

10. PRECAUTIONS and WARNINGS

We herewith give a list of some precautions and warnings concerning the application and installation of the electronic pressure – and level transmitters, **SERIES-RANGE-VALVE**

- **Check if the specifications of the transmitter meet the needs of the process conditions. BE SURE THE VALVE IS CLOSED WHEN TRANSMITTER IS RETRACTED FROM VALVE**
- **When the Series 2000-VALVE-RANGE is used as a level transmitter, be aware of the place where the transmitter is mounted. Here are some suggestions:**
 1. **DO NOT** mount a level transmitter in- or near filling or discharging pipes.
 2. **In case of automatic cleaning systems or hand cleaning: never point the water jets on the diaphragm, take necessary steps to avoid this. Guarantee will not be granted.**
- **When the Series 2000-VALVE-RANGE is used as a pressure transmitter, be aware of the following points:**
 1. **Rapid closing valves in combination with high flow velocity will cause water hammer(spikes) and can destroy the transmitter. DO NOT** mount a transmitter near such valves, always a few pipe bends away up or down stream (avoid suction).
 2. **Install a pressure transmitter a few pipe bends away from pumps, as well on the suction or pressure side of the pump**
- **WELDING ADVISEMENT:**
When using the SERIES 2000-VALVE-RANGE the welding advisements on page 4/5/6 must be followed exactly. This is very important to prevent distortion of the weld spud.
- **The diaphragm of the SERIES 2000-VALVE-RANGE is protected with a special protection cap. Protect the diaphragm until installation takes place, to prevent damaging of the diaphragm.**
- **As soon as the wiring is brought inside through the PG9 cable gland and connected to the terminal board, make sure the cable gland is tightly fixed, so that moisture cannot enter into the electronic housing.**
- **NEVER unscrew the venting (3), because it is especially designed to prevent moisture from entering into the electronic housing. If the ambient conditions are very wet, we advise to use a venting through the cable. A special vented cable can be delivered on request.**
- **Avoid high pressure water-jets pointed at the venting. The cover must be fully engaged so that moisture cannot enter into the electronic housing.**
- **WARRANTY: The warranty is 1 year from delivery date. Klay Instruments B.V. does not accept liability for consequential damage of any kind due to use or misuse of the Series 2000-VALVE. Warranty will be given, to be decided by the manufacturer. Transmitter must be shipped prepaid to the factory on manufacturers authorization.**
- **NOTE: Klay Instruments B.V. reserves the right to change its specifications at any time, without notice. Klay Instruments B.V. is not an expert in the customer's process (technical field) and therefore does not warrant the suitability of its product for the application selected by the customer.**

Manufactured by:

 **KLAY-INSTRUMENTS B.V.**

www.klay-instruments.com

Nijverheidsweg 5
P.O. Box 13
Tel: +31-521-591550
Fax: +31 -521-592046

7991 CZ DWINGELOO
7990 AA DWINGELOO
The Netherlands
E-mail: info@klay.nl