

User Manual



**Gas Mass Flow Meter** VB.1

Model MF5100

# Gas Mass Flow Meter

with MEMS calorimetric sensing technology

MF5100 Series

## User Manual

Document No. 03-2021-M10 EN

Issue date: 2021.03

Revision: VD.1

### Siargo Ltd.

3100 De La Cruz Boulevard, Suite 210

Santa Clara, CA 95054

USA

Tel: +1(408)969.0368

Email: [info@siargo.com](mailto:info@siargo.com)

© Copyright 2021 by Siargo Ltd.

Siargo Ltd. and its subsidiaries reserve the right to change the specifications and/or descriptions without prior notice.

 **Attention!**

- Please carefully read this manual prior to operating this product.
- Do not open or modify any hardware which may lead to irrecoverable damage.
- Do not use this product if you suspect any malfunctions or deflection.
- Do not use this product for corrosive media or in a strong vibration environment.
- Use this product according to the specified parameters.
- Only the trained or qualified personnel shall be allowed to perform product services.

 **Use with caution!**

- Be cautious for the electrical safety, even it operates at a low voltage, or battery, any electrical shock might lead to some unexpected damages.
- The gas to be measured should be clean and free of particles. Do not apply this meter for liquid medium.
- Do not apply for any unknown or non-specified gases that may damage the product.
- For remote data, please be sure the meter is properly configured.

## Table of Contents

1. Overview .....	5
2. Receipt / unpack of the products .....	6
3. Knowing the products.....	7
3.1. Product description .....	7
3.2. LCD description .....	7
3.3. Power and data cable description.....	8
3.4. Mechanical dimensions.....	9
4. Installation.....	10
5. Operation and MENU description.....	14
5.1. Check the product specifications .....	14
5.2. Check the leakage .....	14
5.3. Power the meter and digital data connection .....	14
5.4. Meter MENU descriptions.....	<b>Error! Bookmark not defined.</b>
5.4.1. Starting the measurement.....	15
5.4.2. MENU entry with a verified password.....	<b>Error! Bookmark not defined.</b>
5.4.3. Set the unit for accumulated flow rate .....	<b>Error! Bookmark not defined.</b>
5.4.4. Set the unit for instant flow rate .....	<b>Error! Bookmark not defined.</b>
5.4.5. Set the response time .....	<b>Error! Bookmark not defined.</b>
5.4.6. Set Gas conversion factor (GCF) for different gas measurement .	<b>Error! Bookmark not defined.</b>
5.4.7. Set the communication protocol .....	<b>Error! Bookmark not defined.</b>
5.4.8. Set the meter address .....	<b>Error! Bookmark not defined.</b>
5.4.9. Change the default password .....	<b>Error! Bookmark not defined.</b>
5.4.10. Reset the offset .....	<b>Error! Bookmark not defined.</b>
5.4.10. Reset the totalizer or accumulated flow rate .....	<b>Error! Bookmark not defined.</b>
5.4.11. Exit the MENU .....	<b>Error! Bookmark not defined.</b>
5.4.12. MENU key sequence for the settings .....	<b>Error! Bookmark not defined.</b>
5.5. RS485 Modbus communication protocol (Mode P2).....	15
5.5.1. Hardware connection.....	15
5.5.2. Communication parameters .....	15

5.5.3. Frame .....	16
5.5.4. Function codes .....	16
5.5.5. Registers .....	17
5.6. Analog output .....	20
5.6.1. 4~20mA output .....	20
6. Product selection and order information .....	21
6.1. Product selection .....	22
6.2. Order contact and customer support .....	22
7. Technical specifications .....	23
8. Technical notes for the product performance .....	25
8.1. Measurement principle .....	25
8.2. Precautions for the best performance of the product .....	25
8.2.1. Comparison with a third party reference meter .....	25
8.2.2. Particle contamination and fluidic cleanness .....	26
8.2.3. Apply to a different gas medium .....	26
9. Troubleshooting .....	27
10. Warranty and Liability .....	28
11. Service contact .....	30
Appendix I: Product evaluation kit .....	31
Appendix II: Document history .....	32

## 1. Overview

All contact information can be found at the end of this manual.

This manual provides essential information for the operation of the MF5100 series of gas mass flow meters for general-purpose gas metrology applications. The product performance, maintenance, and trouble-shooting as well as the information for product order, technical support, and repair are also included.

MF5100 mass flow meters are designed for general purpose precise industrial gas measurement, monitor, or control. The meter series offer reading accuracy at a large dynamic range, and options for battery power. Additionally, the meter is capable of build-in gas recognition for the pre-calibrated gases, offering seamlessly switching among different gases with distinct thermal properties.

The meters are operated with Siargo's proprietary MEMS calorimetric mass flow sensors together with the smart control electronics. The sensor surface is passivated with silicon nitride ceramic materials together with a water/oil proof nano-coating for performance and reliability. The meter body is made of stainless steel that is available for applications of most of the gases.

## 2. Receipt / unpack of the products

Upon receipt of the products, please check the packing box before the dismantlement of the packing materials. Ensure no damages during shipping. If any abnormality is observed, please contact and notify the carrier who shipped the product and inform the distributors or sales representatives if the order is not placed directly with the manufacturer, otherwise, the manufacturer should be informed as well. For any further actions, please refer to the return and repair section in this manual.

If the packing box is intact, proceed to open the packing box, and you shall find the product (either the meter or the meter with valve per the actual order). The power adapter and/or data cable as shown below may also be found according to your actual order.

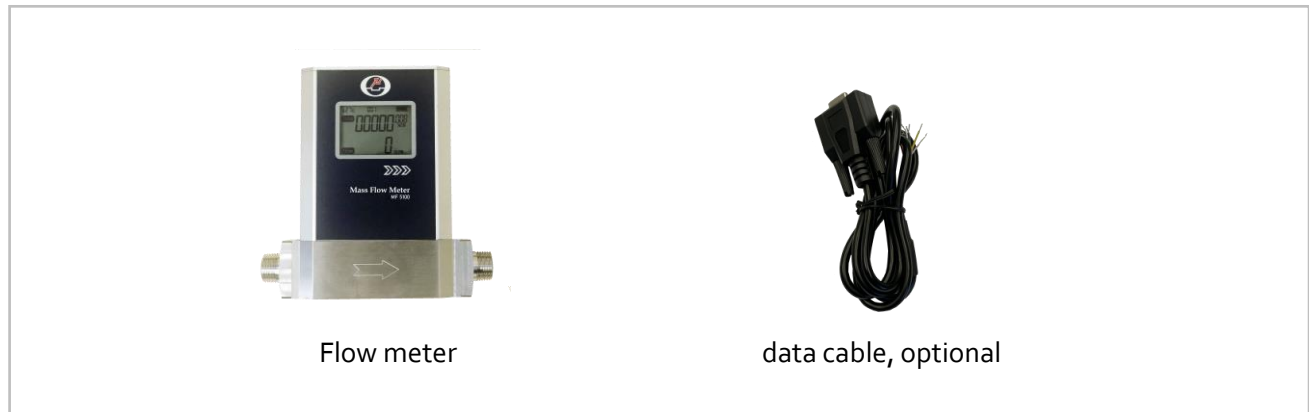

Please check immediately for the integrity of the product as well as the power and data cable, if any abnormal is identified, please notify the distributor/sales representative or manufacturer as soon as you can. If any defects are confirmed, an exchange shall be arranged immediately via the original sales channel. (Note: the LCD screen shall not be lighted until the power cable is plugged in or the battery is installed). This user manual shall also either be included in the packing box or via an online request for an electronic version. In most cases, this manual shall be made available to the customer before the actual order.

The optional cable is a standard one with a DB9 connector. The recommended lithium-ion battery (Tadiran TL 5930 or SAFT LS33600, both are 3.6Vdc, 19Ah) shall be purchased by the user at local supply due to the freight restrictions.

### 3. Knowing the products

#### 3.1. Product description





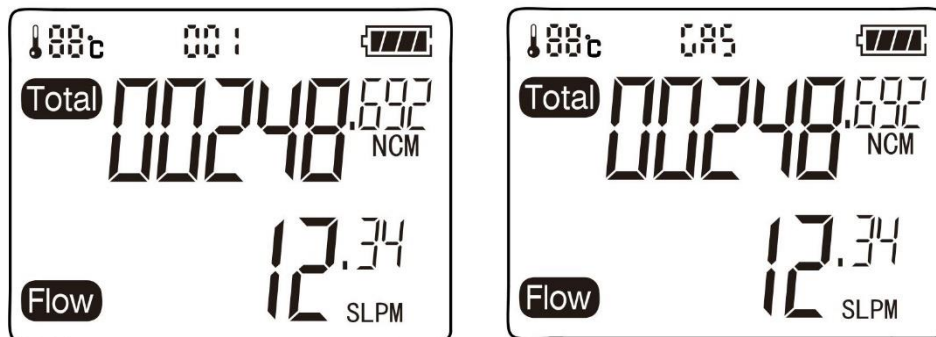

#### 3.2. LCD description



The LCD provides all information that the product measures. Some symbols are reserved for future upgrades, and will not be lighted during the operation. The following table details the meaning of each of the symbols.

001	The value is the Modbus address of the meter
Total	The value next to the symbol is the totalizer or accumulated flow rate in SL (standard liters) or NCM (Normalized cubic meters). Here the standard (normalized) conditions refer to 20°C, 101.325kPa.



	The value next to the symbol is the instant flow rate in SLPM (Standard Liters per minute)
	When the meter is switched to measure a different gas other than the one at the time of shipping, the meter will try to identify the gas, and if a pre-stored gas is matched, this symbol will be displayed instead of the meter Modbus address.
	Status of the battery, when the meter is operating with the battery power.
	Temperature, for models with temperature option

### 3.3. Power and data cable description

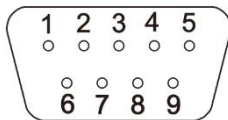

Table 3.3: MF5100 wire assignments.

Wire	Color	Definition
1	Purple	4~20 mA, output
2	Brown	RS485B
3	Transparent	Analog output, 0~5Vdc
4	Yellow	Pulse, output
5	White	Pulse or 4~20mA, ground
6	Blue	N.C.
7	Green	RS485A
8	Black	Ground, common
9	Red	Power supply, 12-24Vdc

### 3.4. Mechanical dimensions

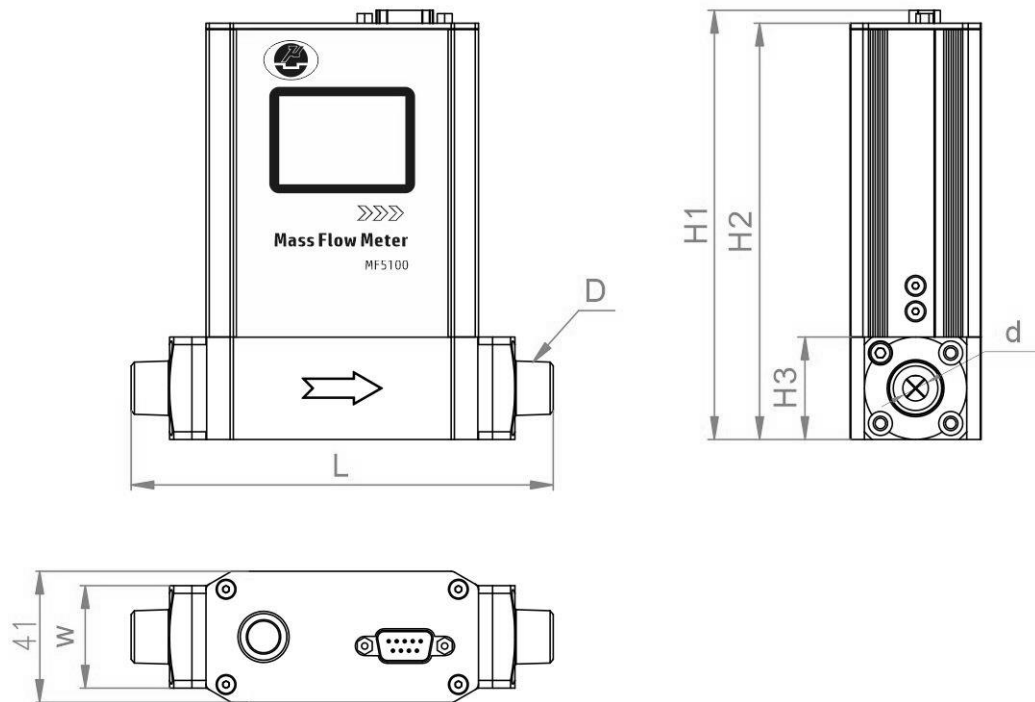
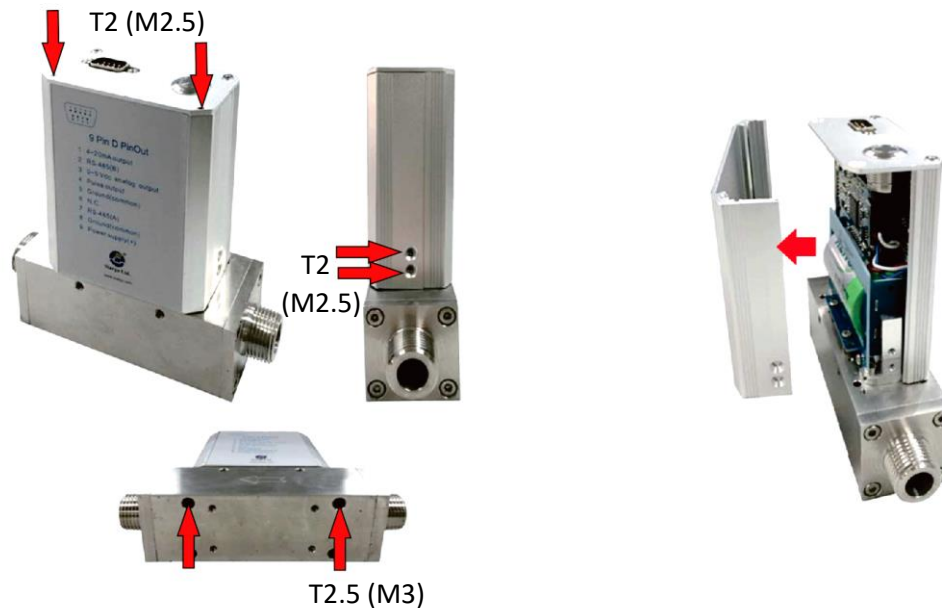

Figure 3.4.1. MF5100 meter dimensions

Model	DN (mm)	D (NPTM)	L	H1	H2	H3	W	d
<b>MF5006</b>	3.00	3/8"	132.0	134.0	130.0	32.0	32.0	Φ3.0
<b>MF5008</b>	6.00	3/8"	132.0	134.0	130.0	32.0	32.0	Φ6.0
<b>MF5010</b>	8.00	3/8"	132.0	134.0	130.0	32.0	32.0	Φ8.0
<b>MF5012</b>	12.00	1/2"	150.0	142.0	138.0	40.0	40.0	Φ12.0
<b>MF5019</b>	19.00	3/4"	182.0	142.0	138.0	40.0	40.0	Φ19.0

## 4. Battery installation

For the battery power options, please refer to the following graph to install a battery (recommended: Tadiran TL 5930 or SAFT LS33600, both are 3.6Vdc, 19Ah. Or a similar one with a safety certificate).



- (a) Removal of the screws with T2 (M2.5) for cover and T2.5 (M3) hex key for meter body, then remove the back cover of the meter head.



- (b) Install the battery – for most of the applications, the battery life should be 3+ years. And re-assemble the back cover of the meter head.

## 5. Meter installation

Do not open or alter any part of the product which would lead to malfunction and irrecoverable damage. It will also forfeit the terms of the warranty and cause liability.

The product at the time of shipment is fully inspected for its quality and meets all safety requirements. Additional safety measures during the installation should be applied. This includes, but is not limited to the leakage verification procedures, standard EDS (electrostatic discharge) precautions, DC voltage precautions. Other tasks such as calibration, part replacement, repair, and maintenance must only be performed by trained personnel. Upon requests, the manufacturer will provide necessary technical support and/or training of the personnel.

The product is preferable to be installed horizontally. Flow direction should be aligned with the arrow mark on the meter body. If the flowing fluid may have particles or debris, a filter is strongly recommended to be installed upstream of the meter.

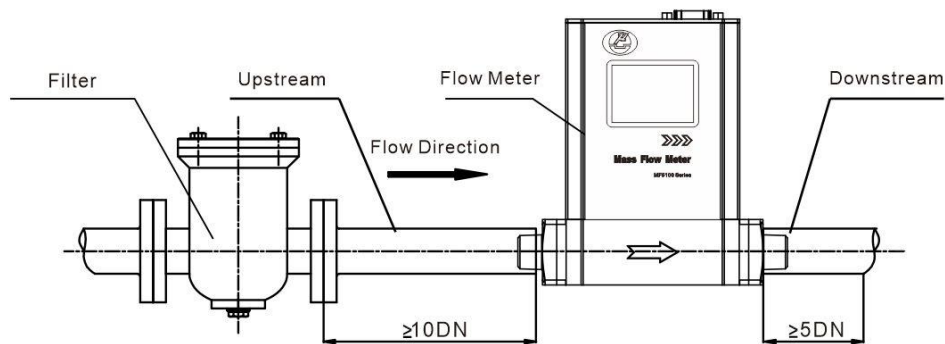

Please follow the following steps to complete the installation:

- a) Upon opening the package, the product's physical integrity should be inspected to ensure no visual damage.
- b) Before installation of the product, please ensure that the pipe debris or particles or any other foreign materials are completely removed.
- c) Cautions during installation:
  - i) It is preferable to first install/connect the meter inlet and then the outlet end of the meter; To ensure the measurement accuracy, an upstream straight pipe of length no less than 10DN and a downstream straight pipe of length no less than 5DN should be in place. Please refer to the following recommended installation configuration.

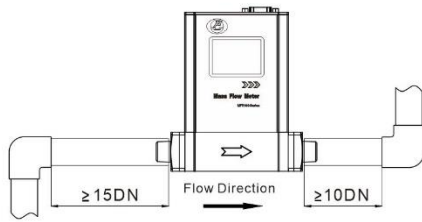

(a) 90-degree elbow or T-piece

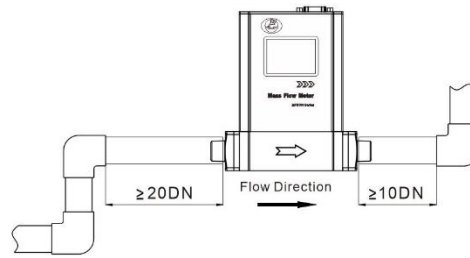

(b) 2x90-degree elbow

- (ii) If the upstream or downstream pipe size is different from that of the product, the size of the installation line pipe diameter(s) should be larger than the flow channel (pipe) size of the meters to be installed. For some typical situations, please follow the installation recommendation detailed in the following sketches.

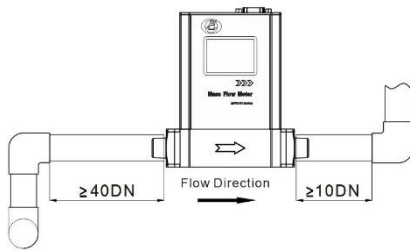

(c) 2x90-degree elbow, 3 D

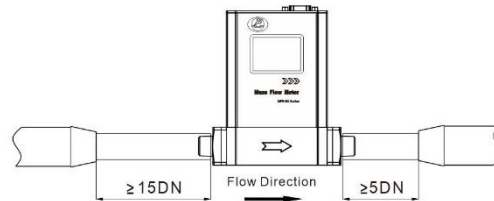

(d) Pipe size-reduction

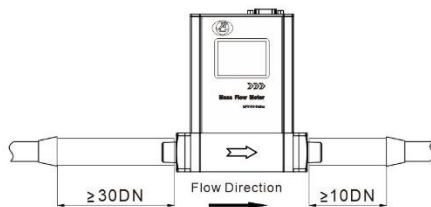

(e) Pipe size expansion

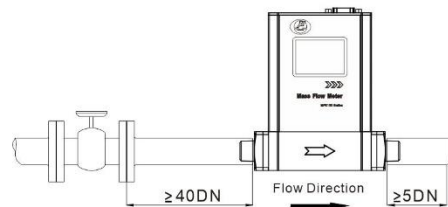

(f) Control valve at upstream or downstream

- (iii) During installation, please make sure no foreign materials (such as water, oil, dirt, particles, etc.) entering into the installation pipeline.

- d) For non-battery power operation, connect electrical wires per the wire definition in Table 3.3. Please be sure of the power supply range (i.e., 12 ~ 24 VDC) and power supply polarization. If an adapter other than the one supplied by the manufacturer, make sure the adapter meets industrial standards and has all safety certifications.

- e) For the data communication wire connection, please follow the description in Table 3.3 and make sure that the wires are correctly connected to the proper ports on your data device/equipment. Please make sure the data cable meets industrial standards with proper shielding.
- f) Once the external power is successfully connected or the battery is installed, the LCD should be lighted up with the proper information displayed works correctly.
- g) Slowly open the valve(s) if any, upstream or downstream or both of the pipeline, and the meter should then start to measure the flow in the pipeline. Note: because the meter has a large dynamical measurement range, it could be normal if you see the small instant flow rate before you open the valve as there could be some leakage. However, make sure the meter reads null when there is no flow present in the pipeline.
- h) This will conclude the installation.



## Cautions

- a) Don't alter any parts of the product.
- b) Ensure the electrical connection is properly done per the instructions.
- c) Make sure no mechanical stresses in the connections.
- d) The strong electromagnetic interference sources close by or any mechanical shocks at the pipeline may also create malfunctioning of the product.
- e) Slowly open/close valves to prevent abrupt pulse flow impact.

## 6. Operation

### 6.1. Check the product specifications

Before starting to use this product, check the product specifications that can be found in this manual or the basic information located on the back panel of the product.

The detailed product technical specifications can be found in Section 8. For a specific application, the pressure rating must not be higher than the system pressure to be measured, and the flow range should also be within the specified ones. In most cases, the use of a high full-scale ranged meter for the very low flow rate measurement often results in erroneous data. The gas to be measured must also be consistent with that specified by the product. Be particularly cautious about the supplied voltage indicated in the specification. A higher voltage may lead to irrecoverable damage, and a lower voltage will not power the product for any desired functions.

For the best performance of the product, it is advised that the gas to be measured must be clean and free of particles or other foreign materials.

### 6.2. Check the leakage

Check gas leakage before any measurement. If it is needed, the pressurized nitrogen or air can be used for the leakage check.

### 6.3. Power the meter and digital data connection

Although this product complies with the CE-required EMC regulations, for the options of external DC power supply, it also requires the product to be used according to the standard electrical device practice. Before connecting the meter with external DC power or an AC-DC adapter, make sure the supply voltage is within the range of the specified ones in Section 8. Be cautious that the standard electrical device precautions such as EDS (electrostatic discharge) and DC voltage are observed. Excessive electrostatic discharge may damage the product.

The manufacturer-supplied power and data cable have a locking fixture. Lock the cable and make sure it is properly engaging and will not be accidentally got unplugged.

Half-duplex RS485 Modbus is used for digital data communication. Make sure the wires are properly connected at the receiver side.

## 6.4. Starting the measurement

Once the power is supplied (either via battery or external DC power) and no abnormal issues are observed, the meter is ready to perform the measurements. The default display is for the mass flow measurement having two numerical lines on the LCD. The middle line is the totalizer or accumulated flow rate, and the lower line is the instant flow rate. The upper line shows the temperature, meter address, and battery status.

## 6.5. RS485 Modbus communication protocol

The digital communication protocol is based on standard Modbus RTU Half-plex mode. A master (PC or PLC) can communicate with multiple slaves (the current product) for data exchange and communication parameter configuration. Refer to Table 3.3 for cable connection.

### 6.5.1. Hardware connection

The hardware layer is TIA/EIA-485-A, as illustrated below. In this configuration, the product (MF5100) is a slave.

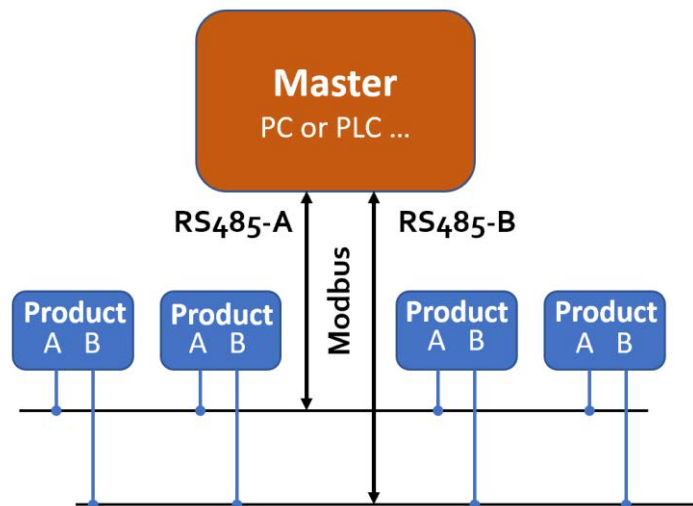

### 6.5.2. Communication parameters

The PC UART communication parameters are listed in the following table.



Parameters	Protocol
	RTU
Baud rate (Bits per second)	9600 bps
Start bits	1
Data bits	8
Stop bits	1
Even/Odd parity	None
Bits period	104.2 $\mu$ sec
Bytes period	1.1458 msec
Maximum data length	20
Maximum nodes	247

### 6.5.3. Frame

The frame function is based on the standard Modbus RTU framing:

Start_bits	Address	Function codes	Data	CRC	Stop_bits
T <sub>1</sub> -T <sub>2</sub> -T <sub>3</sub> -T <sub>4</sub>	8 bit	8 bit	N 8 bit (20 $\geq$ n $\geq$ 0)	16 bit	T <sub>1</sub> -T <sub>2</sub> -T <sub>3</sub> -T <sub>4</sub>

**Start\_bits:** 4 periods bit time, for a new frame.

**Address:** The address can be set from 0 to 247 except for 157 (0x9d). 0 is the broadcast address.

**Function codes:** Define the product (MF5100)'s functions/actions (slaves), either execution or response.

**Data:** The address of the register, length of data, and the data themselves.

**CRC:** CRC verification code. The low byte is followed by the high byte. For example, a 16 bit CRC is divided into BYTE\_H and BYTE\_L. In the framing, the BYTE\_L will come first, then followed by the BYTE\_H. The last one is the STOP signal.

**Stop\_bits:** 4 periods bit time, for ending the current frame.

### 6.5.4. Function codes

The Modbus function codes applied for the product are the sub-class of the standard Modbus function-codes. These codes are used to set or read the registers of the product:

Code	Name		Functions
0x03	Read register	Int, char, float	Read register(s)
0x06	Set single register	Int, char, float	Write one single 16-bit register
0x08	CRC verification	Int	Verify the communication
0x10	Set multiple registers	Int, char, float	Write multiple registers

### 6.5.5. Registers

The product (MF5100) has multiple registers available for the assignment of the various functions. With these functions, the user can obtain the data from the products, such as *product address* and *flow rates* from the registers, or set the product functions by writing the corresponding parameters.

The currently available registers are listed in the following table, and the registers may be customized upon contact the manufacturer. Where R: read; W: write-only; W/R: read and write.

**Note: At the time of shipping, the write protection function is enabled except for address and baud rate. Once the user completes the register value change, the write protection will be automatically enabled once again to prevent incidental data loss.**

Functions	Description	Register	Modbus reference
Address	Product address (R/W)	0x0081	40130 (0x0081)
Serial number	Serial number of the product	0x0030~0x0035	40049 (0x0030)
Flow rate	Current flow rate (R)	0x003A~0x003B	40059 (0x003A)
Totalizer	Totalizer or accumulated flow rate (R)	0x003C~0x003E	40061 (0x003C)
GCF	Gas correction factor (R/W)	0x008B	40140 (0x008B)
Maximum flowrate	Set maximum flowrate (R/W)	0x0085	40134 (0x0085)
Pulse rate	Set pulse rate (totalizer flowrate) (R/W)	0x93	40148 (0x0093)
GC_air	Gas identification, air (R/W)	0x91	40146 (0x0091)
GC_gas	Gas identification, gas (R/W)	0x53	40084 (0x0053)
GC_threshold	Gas identification limit (R/W)	0x92	40147 (0x0092)
Write protection	Write protection of selected parameters (W)	0x00FF	40256 (0x00FF)

The detailed information of each register is described below: Y: enabled; N: disabled

<b>Address</b>	<b>0x0081</b>	<b>Write</b>	Y
		<b>Read</b>	Y
<b>Description</b>	Address of the product		
<b>Value type</b>	UNIT 16		
<b>Notes</b>	Values from 1 to 247 except for 157 (0x9d). 0 is the broadcast address.		

<b>Serial number, SN</b>	<b>0x0030...0x0035</b>	<b>Write</b>	N
		<b>Read</b>	Y
<b>Description</b>	Series Number of the product, SN		
<b>Value type</b>	UNIT 8 (12bits)		
<b>Notes</b>	SN= value(0x0030), value(0x0031),...,value (0x0035); Receiving 12 bits as: 2A 47 37 41 45 49 30 32 30 35 38 2A , the corresponding Serial Number is *G7AEI02058*.		

<b>Flow rate</b>	<b>0x003A ~ 0x003B</b>	<b>Write</b>	N
		<b>Read</b>	Y
<b>Description</b>	Current flow rate		
<b>Value type</b>	UNIT 16		
<b>Notes</b>	Flow rate = [Value (0x003A)*65536 + value (0x003B)]/1000 e.g.: for a flow rate of 123.456 SLPM, the user will read "1 (0x0002)" from register 0x003A and "57920 (0xE240)" from register 0x003B, therefore Current flow rate = (1*65536+57920)/1000 = 123.456		

<b>Totalizer</b>	<b>0x003C ~ 0x003E</b>	<b>Write</b>	Y
		<b>Read</b>	Y
<b>Description</b>	Totalizer or accumulated flow rate		
<b>Value type</b>	UNIT 32 + UNIT 16		
<b>Notes</b>	A1 = Value (0x003C) * 65536 + Value (0x003D) A2 = Value (0x003E) Totalizer or accumulated flow rate = (A1 * 1000 + A2)/1000 e.g.: for a totalizer or accumulated flow rate of 3452.245 m <sup>3</sup> , the user will read "0 (0x0000)" from register 0x003C; "3452(0x0D7C)" from register 0x003D, and "245(0x00F5)" from register 0x003E. Then, the totalizer or accumulated flow rate = ((0 + 3452)*1000 + 245)/1000=3452.245.		

<b>Maximum flow rate</b>	<b>0x0085 ... 0x0086</b>	<b>Write</b>	Y
		<b>Read</b>	Y
<b>Description</b>	Set the maximum flow rate limit		
<b>Value type</b>	UNIT 16		
<b>Notes</b>	Maximum flow rate limit =(Value(0x0085)*65536+Vlaue(0x0086))/1000 e.g.: to set a maximum flow rate limit of 30 SLPM, write 0 to register 0x0085, and write 30000 to register 0x0086. Then the value will be (0*65536+30000)/1000 = 30		

GCF	0x008B	Write	Y
		Read	Y
Description	The gas conversion factor for using with gas different from calibration gas		
Value type	UNIT 16		
Notes	The air (default) is 1000, normally read from register 0x008B. <b>The product will disable this function with write protection once the metering gas is confirmed with the proper GCF. For a specific GCF value, please contact the manufacturer.</b>		

GC_air	0x91	Write	Y
		Read	Y
Description	This value is the gas ID for air		
Value type	UNIT 16		
Notes	The default value is 32768±200. This value may be dependent on the actual offset value of the meter.		

GC_gas	0x53	Write	Y
		Read	Y
Description	This value is assigned for a specific gas at the time of order		
Value type	UNIT 16		
Notes	The default value for methane or natural gas is 35800±200, and for CO <sub>2</sub> is 29200±200. For other gases, please contact the manufacturer. Once it is set, the meter can automatically switch the calibration between air (calibrated gas) and the set gas.		

GC_threshold	0x92	Write	Y
		Read	Y
Description	Set a limit for the gas switch		
Value type	UNIT 16		
Notes	The default value is 1000, and the maximum of 10000. For example: If $GC\_gas \geq GC\_air + GC\_threshold$ , or $GC\_gas \leq GC\_air - GC\_threshold$ , then $Flowrate\_gas = flowrate\_air * GCF / 1000$ , and the "GAS" symbol will be displayed on the LCD, replacing the meter address value. If the GC_threshold is set to be 10000, this function will be disabled.		

Pulse	0x93	Write	Y
		Read	Y
Description	Set the pulse rate for totalized flow rate		
Value type	UNIT 16		
Notes	The default value is 100 or 10mL/pulse. Available values are: 1=0.1mL; 10=1 mL; 100=10mL; 1000=100mL; and 10000=1000mL (1L) per pulse.		

Write protection	0x00FF	Write	Y
		Read	N
Description	Write protection disabler for a set value to a specific register.		
Value type	Unsigned int, Fixed value 0xAA55		
Notes	<p>This function is enabled at the time of product shipment. To enable the write function of a specific parameter, such as GCF, the user needs to send 0xAA55 to the register 0x00FF, and then the write function will be enabled (write protection is disabled). After the write execution is completed, the firmware will automatically re-enable the write protection.</p> <p>Only <b>Address</b> will not be write-protected.</p>		

## 6.6. Analog output

### 6.6.1. 4~20mA output

The loop resistor connection is illustrated below. The current output load depends on the power supply (the yellow area in the graph). The maximum load resistor,  $R_L$ , with a 24Vdc supply, will be 850Ohm.

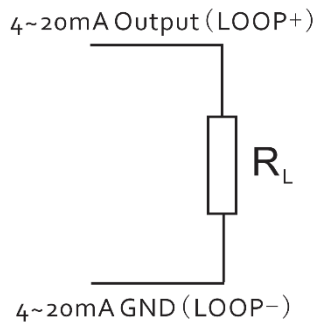
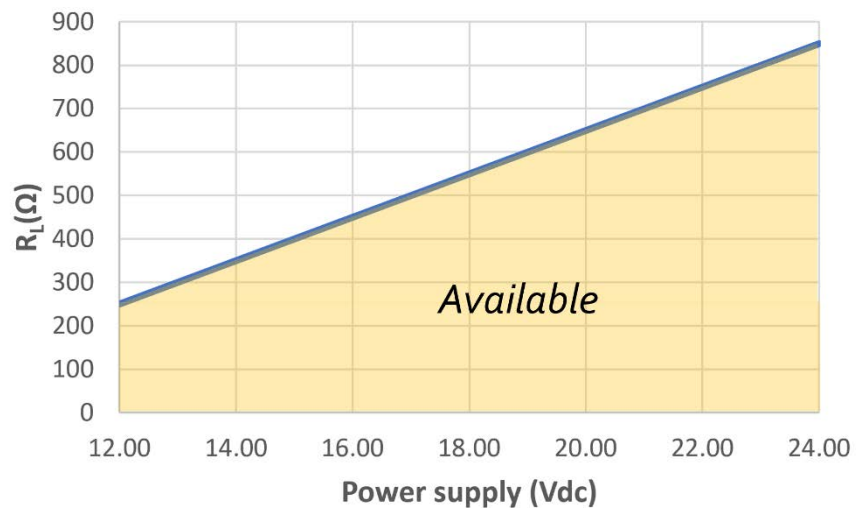

Figure 5.6.1. Analog output.



### 6.6.2. Pulse output

The pulse output for the accumulated flow rate is an even square wave having 3.3 Vdc high and 0 Vdc low. The pulse can be programmed to 0.01 SL, 0.1 SL, 1 SL or 10L/pulse. The default value is 1.00 SL/pulse.

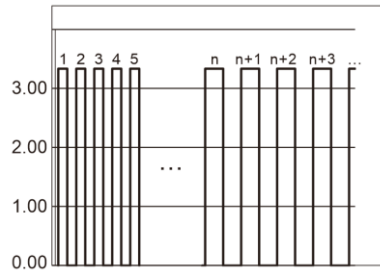

Figure 5.6.2. Pulse output for accumulated flow rate.

### 6.6.3. Voltage output

For 0~5.0Vdc analog output, an external power supply is required. The connection of the analog output is illustrated below.

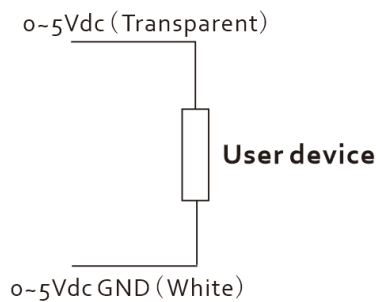

Figure 5.6.4. Voltage output connection.

## 7. Product selection and order information

### 7.1. Product selection

The product part number is composed of the product model number and suffixes indicating the full-scale flow rate, as well as the other parameters. Refer to the following for details.

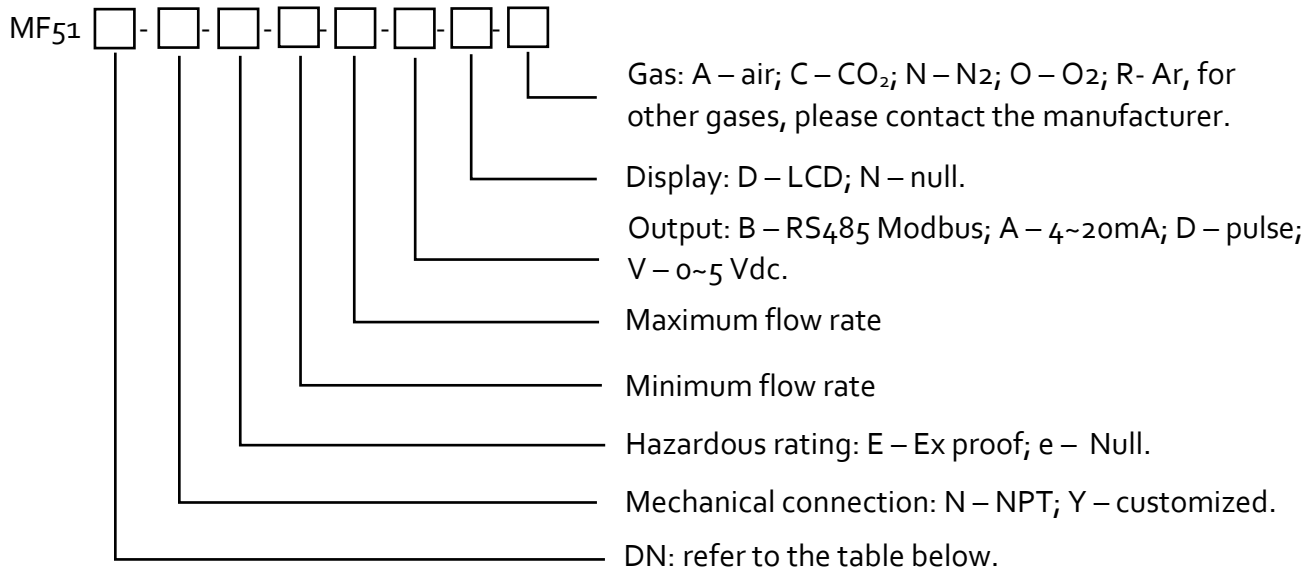

Table 7.1.1. Maximum and minimum flow range of all models.

Model	DN (mm)	DN (")	Flow range		
			sccm	SLPM	SCFM
MF5106	6.0	3/8"	30~30000	0.30~30.00	-
MF5108	8.0	3/8"	-	0.50~50.00	0.02~2.00
MF5110	10.0	3/8"	-	1.20~120.00	0.04~4.20
MF5112	12.0	1/2"	-	3.00~300.00	0.10~10.00
MF5119	19.0	3/4"	-	8.00~800.00	0.28~28.00

### 7.2. Order contact and customer support

The sales offices and the sales distributors/representatives are listed at the end of this document.

Siargo is making every effort to ensure the quality of the products. In case of questions and/or product supports, please contact the customer service listed at the end of the document.

## 8. Technical specifications

### 8.1. Technical specifications

	Value	Unit
Full-scale flow range	See table 7.1.1	SLPM
Accuracy	±1.5	%
Repeatability	0.5	%
Turn-down ratio	100:1	
Working temperature	-10~55	°C
Maximum pressure	1.0	MPa
Burst pressure	1.5	MPa
Humidity	<95, no condensation	%RH
Power supply	12~24 (50 mA) or Lithium-ion D-Cell 3.6V, 19Ah	
Battery life	>2.0	Years
Digital output	RS485 Modbus half-duplex / 4~20 mA / Pulse / Voltage 0~5Vdc	
Display	LCD	
Mechanical connection	NPT or customized	
Gas ID	2 or more gases	
Storage temperature	-20 ~ 70	°C
Reference conditions	20°C, 101.325 kPa, air	
Fluid compatibility	Non-corrosive	
CE	EN61326-1; -2; -3	

	MF5106	MF5108	MF5010	MF5112	MF5119	
Maximum overflow	100	200	300	450	1200	SLPM
Maximum flow change	15	30	45	60	150	SLPM/sec

- Note:**
1. For other features or specifications not listed, please contact the manufacturer.
  2. All specifications listed in the following table unless otherwise noted apply for calibration conditions at 20°C and 101.325 kPa absolute pressure with air. The product is horizontally mounted at the time of calibration.



### 8.2. Pressure loss

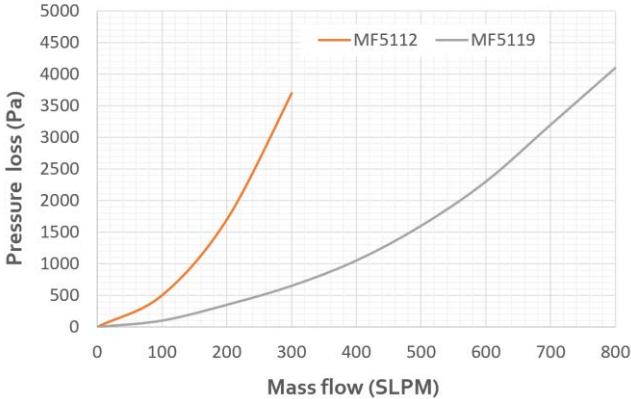
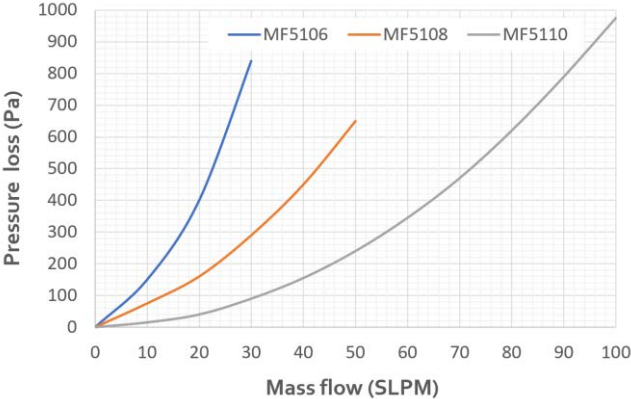

## 9. Technical notes for the product performance

### 9.1. Measurement principle

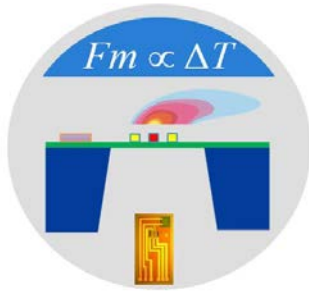

Figure 8.1. Measurement approach illustration.

The products utilize the Company's proprietary micro-machined (MEMS) calorimetric sensing and data process technology. A thermal signal generator with a pair of sensing elements at the up and downstream of the microheater is precisely manufactured and separated at predefined micrometer distances on a chip surface with excellent thermal isolation. When a fluid is flowing through the sensing chip, the fluid carries the thermal signal downstream. The sensing elements register the temperature differences, further correlated to the fluid mass flow rate via the calibration process.

The calorimetric sensing approach offers a large dynamic range with a better performance against the environmental parameter alternations.

Please refer to the company's US patents and other publications made available to the public for additional information.

### 9.2. Precautions for the best performance of the product

#### 9.2.1. Comparison with a third party reference meter

It is very common that a user may compare the data from the product with a third-party reference meter, and in many cases, there could be some discrepancies.

When performing such a comparison, please note that the reference meter should have a better-specified accuracy (about 1/3 of the product), and pay special attention to the differences in the reading accuracy and full-scale accuracy.

A full scale accuracy = reading accuracy x (full scale flow rate/ set point (current) flow rate)

Another key point to compare the different flow meter is that as long as the fluidic flow is a continuous flow without pulsation, then the fluidic dynamic will have the system following the Bernoulli equation:

$$P_1 + \frac{1}{2}\rho v_1^2 + \rho g h_1 = P_2 + \frac{1}{2}\rho v_2^2 + \rho g h_2$$

where  $\rho$  is the fluid density;  $g$  is the acceleration due to gravity;  $P_1$  is the pressure of the reference meter;  $P_2$  is the pressure at the test meter;  $v_1$  is the velocity of the reference meter, and  $v_2$  is the velocity of the test meter.  $h_1$  and  $h_2$  are the corresponding height for the meters which in most cases is the same in the system. Therefore, it would be very critical to have the system does not have a pressure variation. (This explains our recommendations for the installations in Section 4). Also, the meter measurement principle is often very important for the understanding of any discrepancies.

### **9.2.2. Particle contamination and fluidic cleanness**

Any contamination including particles and liquid vapors would be detrimental to the accuracy of the flow measurement and also to the meter functionality. It is important to ensure the applied flow medium will be clean and dry. If any contamination is suspected, please allow experienced technical personnel to have it checked and re-conditioned. Do not use a foreign cleanser or other fluids to clean the flow path which could bring irrecoverable damage.

### **9.2.3. Apply to a different gas medium**

The product is calibrated with a high precision NIST traceable metrological standard with clean and dry air. In case the meter will be applied to meter the other clean and dry gas, this meter offers a unique solution.

The meter operates similar to the principle described in the international standard for thermal mass flow meters (ISO 14511:2001 - Measurement of fluid flow in closed conduits — Thermal mass flowmeters). By measuring the gas thermal conductivity and thermal capacitance, the technology allows the meter to identify any gases with distinct thermal parameters, and therefore, it will be able to automatically switch the pre-calibrated data for the correct gas measurement. For further information, please contact the manufacturer.

## 10. Troubleshooting

Phenomena	Possible causes	Actions
No signal / display	Power not connected; battery empty	Connect the power, check the cable
	Cable connection incorrect	Check cable
	No flow or clogging	Check flow and contamination
	Power regulator failure	Return to factory
	Sensor failure	Return to factory
Large errors or unexpected flow rate	Particles, fluid type	Check system
Erroneous or large noise	Vibration, unstable flow	Check system
Valve not work	Wire connection, valve	Return to factory
Offset unstable	Circuitry instability	Check system, power off
No digital interface	Wrong address, software	Check commands, connection
No wireless, BT cannot pair	Wrong model, data jam	Check model, power off/on

## 11. Warranty and Liability

(Effective January 2018)

Siargo warrants the products sold hereunder, properly used, and properly installed under normal circumstances and service. As described in this user manual, it shall be free from faulty materials or workmanship for 180 days for OEM products and 365 days for non-OEM products from the date of shipment. This warranty period is inclusive of any statutory warranty. Any repair or replacement serviced product shall bear the same terms in this warranty.

Siargo makes no warranty, representation, or guarantee and shall not assume any liability regarding the suitability of the products described in this manual for any purposes that are not specified in this manual. The users shall be held for full responsibility for validating the performance and suitability of the products for their particular design and applications. For any of the misuse of the products out of the scope described herein, the user shall indemnify and hold Siargo and its officers, employees, subsidiaries, affiliates, and sales channels harmless against all claims, costs, damages, and expense or reasonable attorney fee from direct or indirect sources.

Siargo makes no other warranty, express or implied, and assumes no liability for any special or incidental damage or charges, including but not limited to any damages or charges due to installation, dismantling, reinstallation, etc. other consequential or indirect damages of any kind. To the extent permitted by law, the exclusive remedy of the user or purchaser, and the limit of Siargo's liability for any and all losses, injuries, or damages concerning the products, including claims based on contract, negligence, tort, strict liability, or otherwise shall be the return of products to Siargo, and upon verification of Siargo to prove to be defective, at its sole option, to refund, repair or replacement of the products. Regardless of form, no action may be brought against Siargo more than 365 days after a cause of action has accrued. The products returned under warranty to Siargo shall be at the user or purchaser's risk of loss and will be returned, if at all, at Siargo's risk of loss. Purchasers or users are deemed to have accepted this limitation of warranty and liability, which contains the complete and exclusive limited warranty of Siargo. It shall not be amended, modified, or its terms waived except by Siargo's sole action.

This manual's product information is believed to be accurate and reliable at the time of release to or made available to the users. However, Siargo shall assume no responsibility for any inaccuracies and/or errors and reserves the right to make changes without further notice for the relevant information herein.

This warranty is subject to the following exclusions:

- (1) Products that have been altered, modified, or have been subject to unusual physical or electrical circumstances indicated but not limited to those stated in this document or any other actions which cannot be deemed as proper use of the products;

- (2) Products that have been subject to chemical attacks, including exposure to corrosive substances or contaminants. In the case of battery usage, long term discharge or leakage induced damages;
- (3) Products that have been opened or dismantled for whatever reasons;
- (4) Products that have been subject to working conditions beyond the technical specification as described by this manual or related datasheet published by the manufacturer;
- (5) Any damages incurred by the incorrect usage of the products;
- (6) Siargo does not provide any warranty on finished goods manufactured by others. Only the original manufacturer's warranty applies;
- (7) Products that are re-sold by unauthorized dealers or any third parties.

## 12. Service contact

Siargo Ltd. is making every effort to ensure the quality of the products. In case of questions, and or product supports, please contact customer service at the address listed below. We will respond to your request in a timely fashion and will work with you toward your complete satisfaction.

Customer service:

Siargo Ltd.  
3100 De La Cruz Boulevard, Suite 210,  
Santa Clara, California 95054, USA  
Phone: +01(408)969-0368  
Email: [info@Siargo.com](mailto:info@Siargo.com)

## Appendix I: Product evaluation kit

Siargo offers a product evaluation kit, including a digital data converter, USB data cable, and a User Application software, that allows the user to evaluate the product performance on a Microsoft Windows-based computer. For some simple applications with digital data transfer, this kit could serve the purpose. The user can read and visualize the flow rate of the product, obtain the totalizer or accumulated flow rate values, and save the data for further analysis. It can read from up to 128 sensors with the RS485 interface in serial.

For further information and purchase of the evaluation kit, please contact the manufacturer or the sales representative.

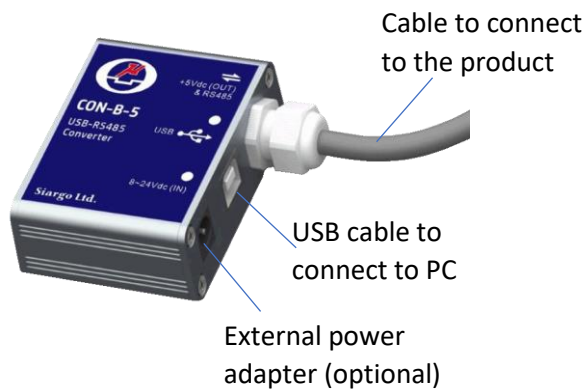

Each converter has a fixed cable that can be directly connected to the product. The USB cable connected to the PC is also included.

For most of the product, the power from the PC via the USB cable will be sufficient to power the sensor product, no external power will be required. However, for multiple sensors in serial, the power via the USB cable may not be enough, an external power adapter with 8~24Vdc will be required.

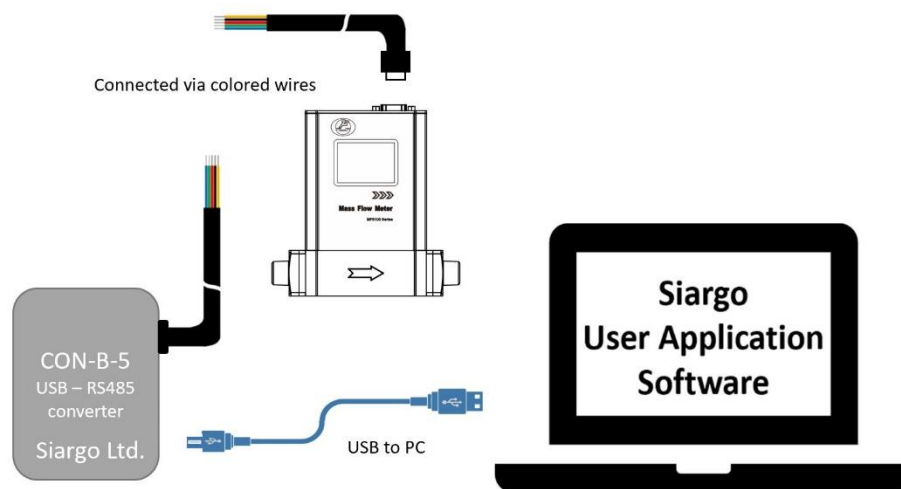



## Appendix II: Document history

Revision B.1 (March 2021)

Reformat, corrections, add the evaluation kit.

Revision A.8 (November 2020):

Update the pressure loss of MF5112 and MF5119. ()

Update the RS485 communication protocol. (Appendix I, Modbus RTU Protocol).

Revision A.7 (June 2019):

Added MF5112 and MF5119 (Specifications, Dimensions, and Descriptions).

Revision A.6 (November 2018):

Corrected the calibrated condition (Specifications).

Revision A.5 (July 2018):

Added the installation instructions (Installation Instructions).

Revision A.4 (October 2017):

Added maximum overflow and maximum flow change (Specifications);

Added the revision history.

---

### SALES REPRESENTATIVE



**SMERI s.r.l.**

I - 20057 Assago (MI) - Via Mario Idiomi 3/13

Tel: +39 02 5398941

E-mail: smeri@smeri.com

www.smeri.com