

Operating manual



Gas Mass Flow Meter VC.1

Model MF5600



Gas Mass Flow Meter

with MEMS calorimetric sensing technology

MF5600 Series

User Manual

Document No. 03-2021-M2 EN

Issue date: 2021.03

Revision: VC.1

Siargo Ltd.

3100 De La Cruz Boulevard, Suite 210

Santa Clara, CA 95054

USA

Tel: +1(408)969.0368

Email: info@siargo.com

© Copyright 2018 by Siargo Ltd.

Siargo Ltd. and its subsidiaries reserve the right to change the specifications and/or descriptions without prior notice.

Attention!

- Please carefully read this manual prior to operating this product.
- Do not open or modify any hardware which may lead to irrecoverable damage.
- Do not use this product if you suspect any malfunctions or deflection.
- Do not use this product for corrosive media or in a strong vibration environment.
- Use this product according to the specified parameters.
- Only the trained or qualified personnel shall be allowed to perform product services.

Use with caution!

- Be cautious for the electrical safety, even it operates at a low voltage, any electrical shock might lead to some unexpected damages.
- The gas to be measured should be clean and free of particles. Do not apply this meter for liquid medium.
- Do not apply for any unknown or non-specified gases that may damage the product.
- For remote data, please be sure the meter is properly configured.

Table of Contents

1. Overview	5
2. Receipt / unpack of the products	6
3. Knowing the products.....	7
3.1. Product description	7
3.2. LCD description	7
3.3. Power and data cable description.....	8
3.4. Mechanical dimensions.....	9
4. Installation.....	9
5. Operation and MENU description.....	13
5.1. Check the product specifications	13
5.2. Check the leakage	13
5.3. Power the meter and digital data connection	13
5.4. Meter MENU descriptions.....	14
5.4.1. Starting the measurement.....	14
5.4.2. MENU entry with a verified password.....	14
5.4.3. Set the unit for accumulated flow rate	15
5.4.4. Set the unit for instant flow rate	15
5.4.5. Set the response time	16
5.4.6. Set Gas conversion factor (GCF) for different gas measurement	16
5.4.7. Set the communication protocol	17
5.4.8. Set the meter address	17
5.4.9. Change the default password	17
5.4.10. Reset the offset	18
5.4.10. Reset the totalizer or accumulated flow rate	18
5.4.11. Exit the MENU	18
5.4.12. MENU key sequence for the settings	19
5.5. RS485 Modbus communication protocol (Mode P2).....	20
5.5.1. Hardware connection.....	20
5.5.2. Communication parameters	20

5.5.3. Frame	21
5.5.4. Function codes	21
5.5.5. Registers	21
5.6. Analog output	23
5.6.1. 4~20mA output	23
6. Product selection and order information	24
6.1. Product selection	24
6.2. Order contact and customer support	24
7. Technical specifications	25
8. Technical notes for the product performance	26
8.1. Measurement principle	26
8.2. Precautions for the best performance of the product	26
8.2.1. Comparison with a third party reference meter	26
8.2.2. Particle contamination and fluidic cleanness	27
8.2.3. Apply to a different gas medium	27
9. Troubleshooting	28
10. Warranty and Liability	29
11. Service contact	31
Appendix I: Product evaluation kit	32
Appendix II: Document history	33

1. Overview

All contact information can be found at the end of this manual.

This manual provides essential information for the operation of the MF5600 series of gas mass flow meters for general-purpose gas metrology applications. The product performance, maintenance, and trouble-shooting as well as the information for product order, technical support, and repair are also included.

MF5600 mass flow meters are designed for general purpose precise industrial gas measurement, monitor, or control. The design opts for applications where the display must be separately placed from the meter body or flow channel.

The meters are operated with Siargo's proprietary MEMS calorimetric mass flow sensors together with the smart control electronics. The sensor surface is passivated with silicon nitride ceramic materials together with a water/oil proof nano-coating for performance and reliability. The current models are ready to connect to 12mm(1/2") or 19mm (3/4") lines while other pipe diameters can be offered as customized models. The meter body is made of stainless steel that is available for applications of most of the gases.

2. Receipt / unpack of the products

Upon receipt of the products, please check the packing box before the dismantlement of the packing materials. Ensure no damages during shipping. If any abnormality is observed, please contact and notify the carrier who shipped the product and inform the distributors or sales representatives if the order is not placed directly with the manufacturer, otherwise, the manufacturer should be informed as well. For any further actions, please refer to the return and repair section in this manual.

If the packing box is intact, proceed to open the packing box, and you shall find the product (either the meter or the meter with valve per the actual order). The power adapter and/or data cable as shown below may also be found according to your actual order.

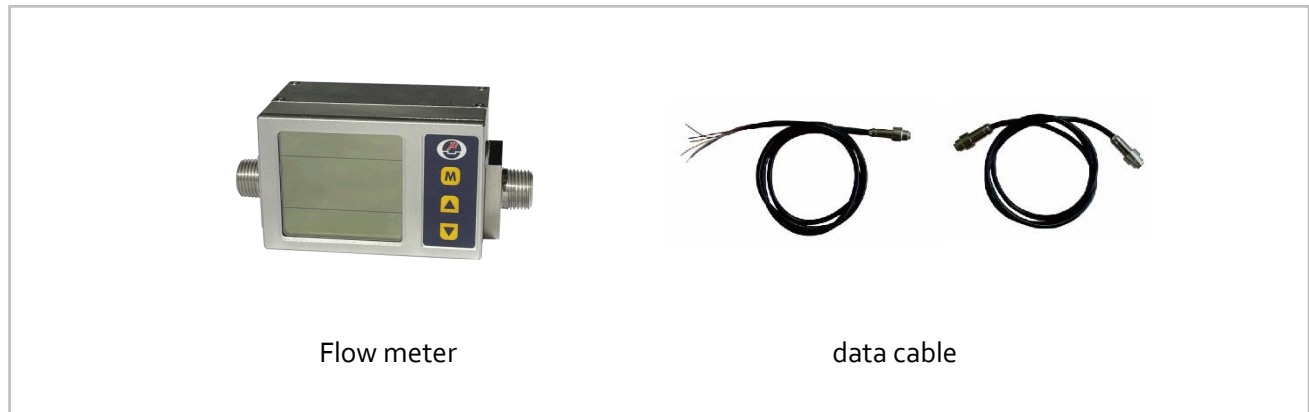

Please check immediately for the integrity of the product as well as the power and data cable, if any abnormal is identified, please notify the distributor/sales representative or manufacturer as soon as you can. If any defects are confirmed, an exchange shall be arranged immediately via the original sales channel. (Note: the LCD screen shall not be lighted until the power cable is plugged in). This user manual shall also either be included in the packing box or via an online request for an electronic version. In most cases, this manual shall be made available to the customer before the actual order.

The two cables are the Accessory Cable 1 for inputs/outputs (Part number: IC7-150, Length: 1.5 m) and the Accessory Cable 2 for the detachable LCD (Part number: IC7-30-IC7, Length: 30 cm; or Part number: IC7-200-IC7, Length: 2 m).

3. Knowing the products

3.1. Product description

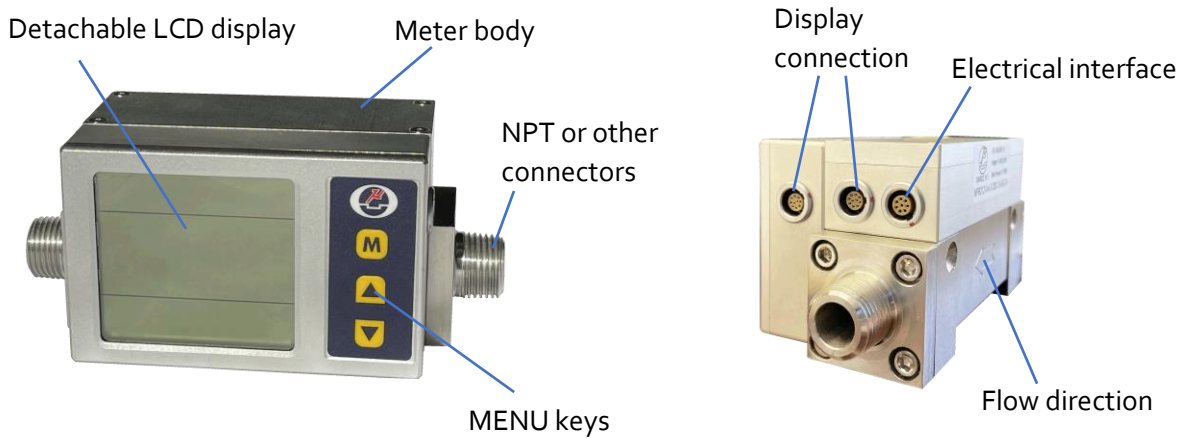

3.2. LCD description

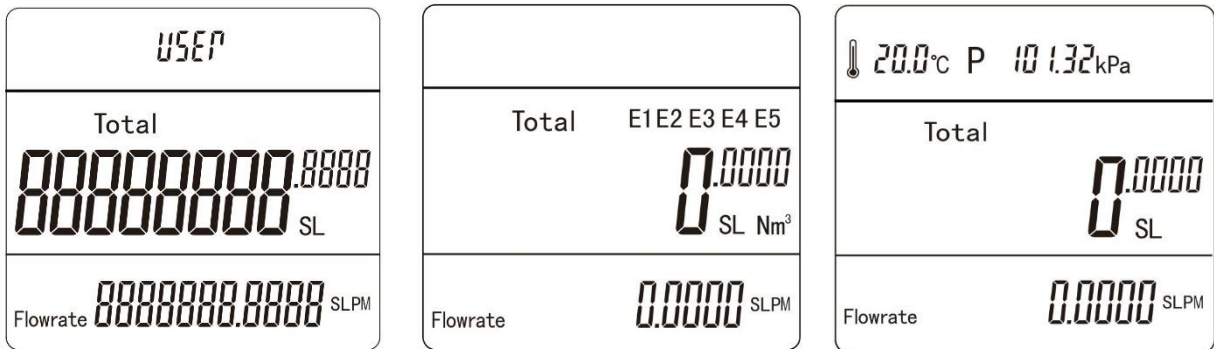

The LCD provides all information that the product measures. Some symbols are reserved for future upgrades, and will not be lighted during the operation. The following table details the meaning of each of the symbols.

USER	The top row, only displayed when communication or other user-defined function is in process.
Total	The middle row displays the totalizer or accumulated flow rate in SL (standard liters) or Nm ³ (Normalized cubic meters). Here the standard (normalized) conditions refer to 20°C, 101.325kPa.

Flowrate	The bottom row displays the instant flow rate in SLPM (Standard Liters per minute)
E1	Error 1 – Sensor error
E2	Error 2 – ADC error
E3	Error 3 – RTC error
E4	Error 4 – EEPROM error
E4	Error 5 – Oscillator (crystal) error
	Temperature, for models with temperature option
P	Pressure, for models with pressure option

***Note:** Both the pressure and temperature sensors can be integrated with the current product but not with the default models. Please contact the manufacturer for further information.

3.3. Power and data cable description

Table 3.3: MF5600 wire assignments.



Wire	Color	Definition
1	Red	Power supply (12~24 Vdc)
2	Black	GND, ground
3	Green	RS485A
4	Brown	RS485B
5	Violet	4~20mA, flow rate output
6	Transparent	4~20mA / pulse ground
7	Yellow	Pulse output

3.4. Mechanical dimensions

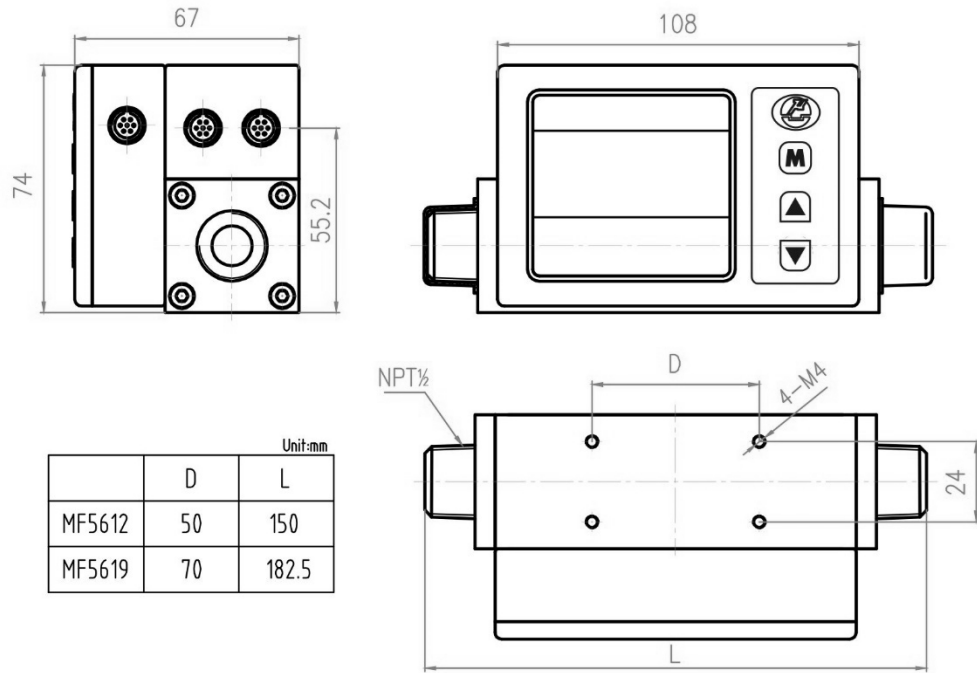

Figure 3.4.1. MF5600 meter dimensions

4. Installation

Do not open or alter any part of the product which would lead to malfunction and irrecoverable damage. It will also forfeit the terms of the warranty and cause liability.

The product at the time of shipment is fully inspected for its quality and meets all safety requirements. Additional safety measures during the installation should be applied. This includes, but is not limited to the leakage verification procedures, standard ESD (electrostatic discharge) precautions, DC voltage precautions. Other tasks such as calibration, part replacement, repair, and maintenance must only be performed by trained personnel. Upon requests, the manufacturer will provide necessary technical support and/or training of the personnel.

The product is preferable to be installed horizontally. Flow direction should be aligned with the arrow mark on the meter body. If the flowing fluid may have particles or debris, a filter is strongly recommended to be installed upstream of the meter.

Please follow the following steps to complete the installation:

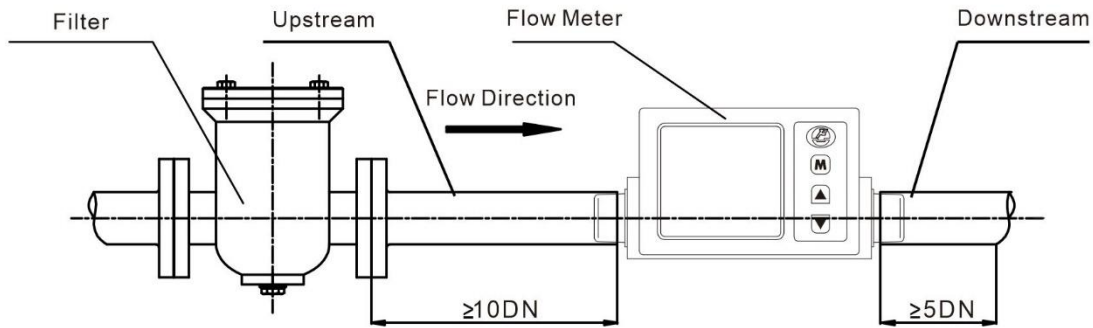

- a) Upon opening the package, the product's physical integrity should be inspected to ensure no visual damage.
- b) Before installation of the product, please ensure that the pipe debris or particles or any other foreign materials are completely removed.
- c) Cautions during installation:
 - i) It is preferable to first install/connect the meter inlet and then the outlet end of the meter; To ensure the measurement accuracy, an upstream straight pipe of length no less than 10DN and a downstream straight pipe of length no less than 5DN should be in place. Please refer to the following recommended installation configuration.

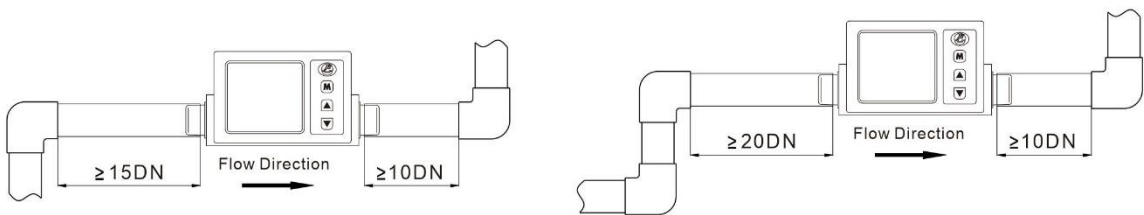

(a) 90-degree elbow or T-piece

(b) 2x90-degree elbow

- ii) If the upstream or downstream pipe size is different from that of the product, the size of the installation line pipe diameter(s) should be larger than the flow channel (pipe) size of the meters to be installed. For some typical situations, please follow the installation recommendation detailed in the following sketches.

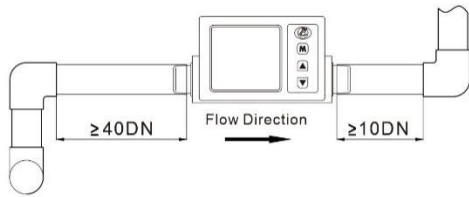

(c) 2x90-degree elbow, 3 D

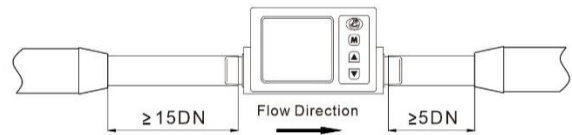

(d) Pipe size-reduction

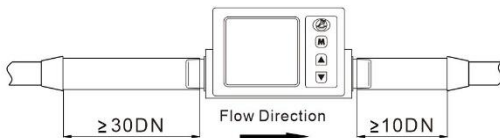

(e) Pipe size expansion

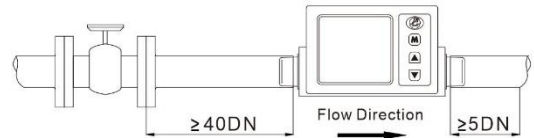

(f) Control valve at upstream or downstream

(iii) During installation, please make sure no foreign materials (such as water, oil, dirt, particles, etc.) entering into the installation pipeline.

- d) Connect electrical wires per the wire definition in Table 3.3. Please be sure of the power supply range (i.e., 12 ~ 24 VDC) and power supply polarization. If an adapter other than the one supplied by the manufacturer, make sure the adapter meets industrial standards and has all safety certifications.
- e) For the data communication wire connection, please follow the description in Table 3.3 and make sure that the wires are correctly connected to the proper ports on your data device/equipment. Please make sure the data cable meets industrial standards with proper shielding.
- f) Once the external power is successfully connected, the LCD should be lighted up with the proper information displayed works correctly.
- g) Slowly open the valve(s) if any, upstream or downstream or both of the pipeline, and the meter should then start to measure the flow in the pipeline. Note: because the meter has a large dynamical measurement range, it could be normal if you see the small instant flow rate before you open the valve as there could be some leakage. However, make sure the meter reads null when there is no flow present in the pipeline.
- h) This will conclude the installation.



Cautions

- a) Don't alter any parts of the product.
- b) Ensure the electrical connection is properly done per the instructions.
- c) Make sure no mechanical stresses in the connections.
- d) The strong electromagnetic interference sources close by or any mechanical shocks at the pipeline may also create malfunctioning of the product.
- e) Slowly open/close valves to prevent abrupt pulse flow impact.

5. Operation and MENU description

5.1. Check the product specifications

Before starting to use this product, check the product specifications that can be found in this manual or the basic information located on the back panel of the product.

The detailed product technical specifications can be found in Section 7. For a specific application, the pressure rating must not be higher than the system pressure to be measured, and the flow range should also be within the specified ones. In most cases, the use of a high full-scale ranged meter for the very low flow rate measurement often results in erroneous data. The gas to be measured must also be consistent with that specified by the product. Be particularly cautious about the supplied voltage indicated in the specification. A higher voltage may lead to irrecoverable damage, and a lower voltage will not power the product for any desired functions.

For the best performance of the product, it is advised that the gas to be measured must be clean and free of particles or other foreign materials.

5.2. Check the leakage

Check gas leakage before any measurement. If it is needed, the pressurized nitrogen or air can be used for the leakage check.

5.3. Power the meter and digital data connection

Although this product complies with the CE-required EMC regulations, it also requires the product to be used according to the standard electrical device practice. Before connecting the meter with external DC power or an AC-DC adapter, make sure the supply voltage is within the range of the specified ones in Section 7. Be cautious that the standard electrical device precautions such as ESD (electrostatic discharge) and DC voltage are observed. Excessive electrostatic discharge may damage the product.

The manufacturer-supplied power and data cable have a locking fixture. Lock the cable and make sure it is properly engaging and will not be accidentally got unplugged.

Half-duplex RS485 Modbus is used for digital data communication. Make sure the wires are properly connected at the receiver side.

5.4. Meter MENU descriptions

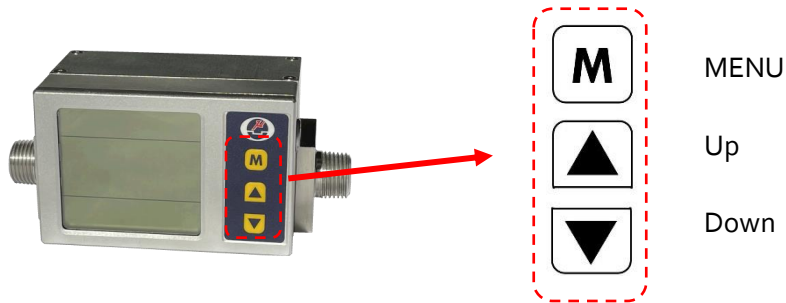

The meter has a front 3-key board for the user to set the desired functions, access data, and check for the status. The Menu key (M) is at the central position that allows the user to select a function and confirmation or other related actions that will be detailed below. Two keys (“Up” and “Down”) to select the menu and sub-menu.

5.4.1. Starting the measurement

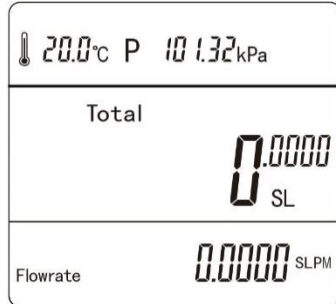

Once the power is supplied and no abnormal issues are observed, the meter is ready to perform the measurements. The default display is for the mass flow measurement having two numerical lines on the LCD. The middle line is the totalizer or accumulated flow rate, and the lower line is the instant flow rate. The upper line will light up when the pressure or temperature option is selected.

5.4.2. MENU entry with a verified password

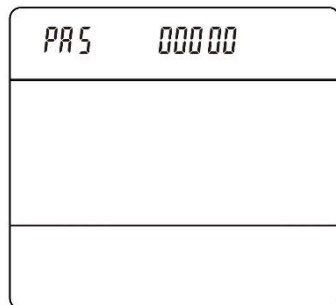

At the flow measurement (main) display, press the central “M” MENU key, it will enter into the password setting and verification MENU. The default password is “11111”. If the password is incorrect, the display will return to the main display.

To enter a new password, press the “Up” or “Down” key to change the digit that flashes, and press the “M” key to confirm. Repeat this process for all 5 digits and the meter will enter into the menu setting interfaces/screen.

Subsequently, the MENU allows the user to set accumulated (totalized) flow rate unit, instant flow unit, response time, the gas conversion factor (GCF), communication protocol, device address, password, offset and reset the accumulation register. Table 5.4 lists the on-screen character and the corresponding functions.

Table 5.4 On-screen characters and their corresponding functions

On-screen character	Symbol	Functions
UnITACC	UnITACC	Accumulated (totalized) flow rate unit
UnITTyPE	UnITTyPE	Instant flow rate unit
InTERVAL	InTERVAL	Interval: response time
SET GCF	SET GCF	Gas conversion factor
PrOTOCOL	PrOTOCOL	Communication protocol
SET Addr	SET Addr	Communication address
SET PAS	SET PAS	Password
OFFSET	OFFSET	Reset offset
CLEAR ^{ACC}	CLEAR ACC	Reset accumulated flow rate register
QUIT	QUIT	Exit the MENU

Note: During this process, the meter will continue to measure the flow without being interrupted.

5.4.3. Set the unit for accumulated flow rate

After the password being verified and entering into the MENU settings, press the “Up” or “Down” key until the screen shows the “UnITACC”

Currently, there are two units to select: “—n3—” or “—SL—”, corresponding to the Nm³ (normalized cubic meter) or SL (standard liter). Note: both units referred to the calibration standard conditions of 20°C and 101.325kPa. Press the “M” key to enter into the change address screen. Press the “Up” or “Down” key to change, and then press the “M” key to confirm. After the selection, press the “M” key to exit the MENU and return to the Main Display screen.

5.4.4. Set the unit for instant flow rate

Following the above-mentioned steps, at the MENU setting screen, press the "Up" or "Down" key until the screen shows the "UnITTyPE"

Currently, there are two units to select: "—n₃—" or "—SL—", corresponding to the Nm³/hr (normalized cubic meter per hour) or SLPM (standard liter per minute). Note: both units referred to the calibration standard conditions of 20°C and 101.325kPa. Press the "M" key to enter into the change address screen. Press the "Up" or "Down" key to change, and then press the "M" key to confirm. After the selection, press the "M" key to exit the MENU and return to the Main Display screen.

5.4.5. Set the response time

Following the above-mentioned steps, at the MENU setting screen, press the "Up" or "Down" key until the screen shows the "InTErVAL"

Currently, the default response time is 125 msec. Press the "M" key to enter into the change response time screen. The following response time options are available: 250 msec, 500 msec, 1000 msec, 2000 msec, and 4000 msec. Press the "Up" or "Down" key to change, and then press the "M" key to confirm. After the selection, press the "M" key to exit the MENU and return to the Main Display screen.

5.4.6. Set Gas conversion factor (GCF) for different gas measurement

For the general purpose of the application, a gas conversion factor (GCF) can be applied to meter the gas different from the default one or the one used for calibration. The GCF is determined by the thermal calorimetric sensing principle as well as the meter fluidic dynamic design and the control circuitry. Contact the manufacturer to obtain the values corresponding to the correct models.

Following the above-mentioned steps, at the MENU setting screen, press the "Up" or "Down" key until the screen shows the "SET GCF"

The manufacturer's GCF for air is 1000. **Note: If the meter during purchase is ordered for a special real gas calibration, contact the manufacturer before further proceeding.** Press the "M" key to enter the change option, and press the "Up" or "Down" key to change, and then press the "M" key to confirm. After the selection, press the "M" key to exit the MENU and return to the Main Display screen.

This GCF factor can also be used equivalent to the "K" factor to adjust the meter due to the system deviations. Take 3 to 5 data points using your preferred reference meter, and perform the least square fitting to identify the K factor, and input here to make the meter synchronize with your system.

5.4.7. Set the communication protocol

Following the above-mentioned steps, at the MENU setting screen, press the “Up” or “Down” key until the screen shows the “PrOTOCOL”

The meter communication can be operated as a single meter or multiple meters via RS485 Modbus communication:

P0-000 – is a communication mode for a single meter.

P1-xxx or P2-xxx (xxx from 001 to 255) – is the RS485 Modbus communication for multiple meters.

Press “M” key to enter the change option, and press the “Up” or “Down” key to change, and then press the “M” key to confirm. After the selection, press the “M” key to exit the MENU and return to the Main Display screen.

5.4.8. Set the meter address

This function allows the user to set the meter address for multiple meter operations with RS485 Modbus. Following the above-mentioned steps, at the MENU setting screen, press the “Up” or “Down” key until the screen shows the “SET Addr”

Currently, the default address is 255. Press the “M” key to enter into the change address screen. The address available is from 001 to 255. Press the “Up” or “Down” key to change, and then press the “M” key to confirm. After the selection, press the “M” key to exit the MENU and return to the Main Display screen.

5.4.9. Change the default password

For data safety, it is recommended that the default password of 11111 should be changed when the first use of this product.

Following the above-mentioned steps, at the MENU setting screen, use the “Up” or “Down” key to enter the password change screen, and it will show the default password of 11111. Press “M” key to enter the change option. Use the “Up” or “Down” and the “M” confirming key to enter the desired one, and press the “M” key again to complete the task and exit.

Please keep the changed password in a safe yet accessible place. In case it is unrecoverable, please contact the manufacturer to obtain a special password to access the meter MENU.

5.4.10. Reset the offset

This function allows the user to reset the offset of the meter. Following the above-mentioned steps, at the MENU setting screen, use the "Up" or "Down" key to enter the "OFFSET" option. Press the "M" key to confirm and use the "Up" or "Down" to select "Yes" or "No" to change or keep the current offset value, and then press the "M" key to confirm and then exit.

5.4.10. Reset the totalizer or accumulated flow rate

As the maximum value of the totalizer or accumulated flow rate that the internal register can have is 9999999, the register will stop accumulating once the value is reached. At this time, it is necessary to reset this register. Following the above-mentioned steps, at the MENU setting screen, use the "Up" or "Down" key to select "CLEAR ACC". Press "M" key to enter the change option, and use the "Up" or "Down" to select "Yes" or "No" to change or keep the current offset value, and then press the "M" key to confirm and then exit.

5.4.11. Exit the MENU

At the MENU settings, use the "Up" or "Down" key to select the qUIT option and press the "M" confirming key to exit the MENU settings and return to the Main Display screen.

5.4.12. MENU key sequence for the settings

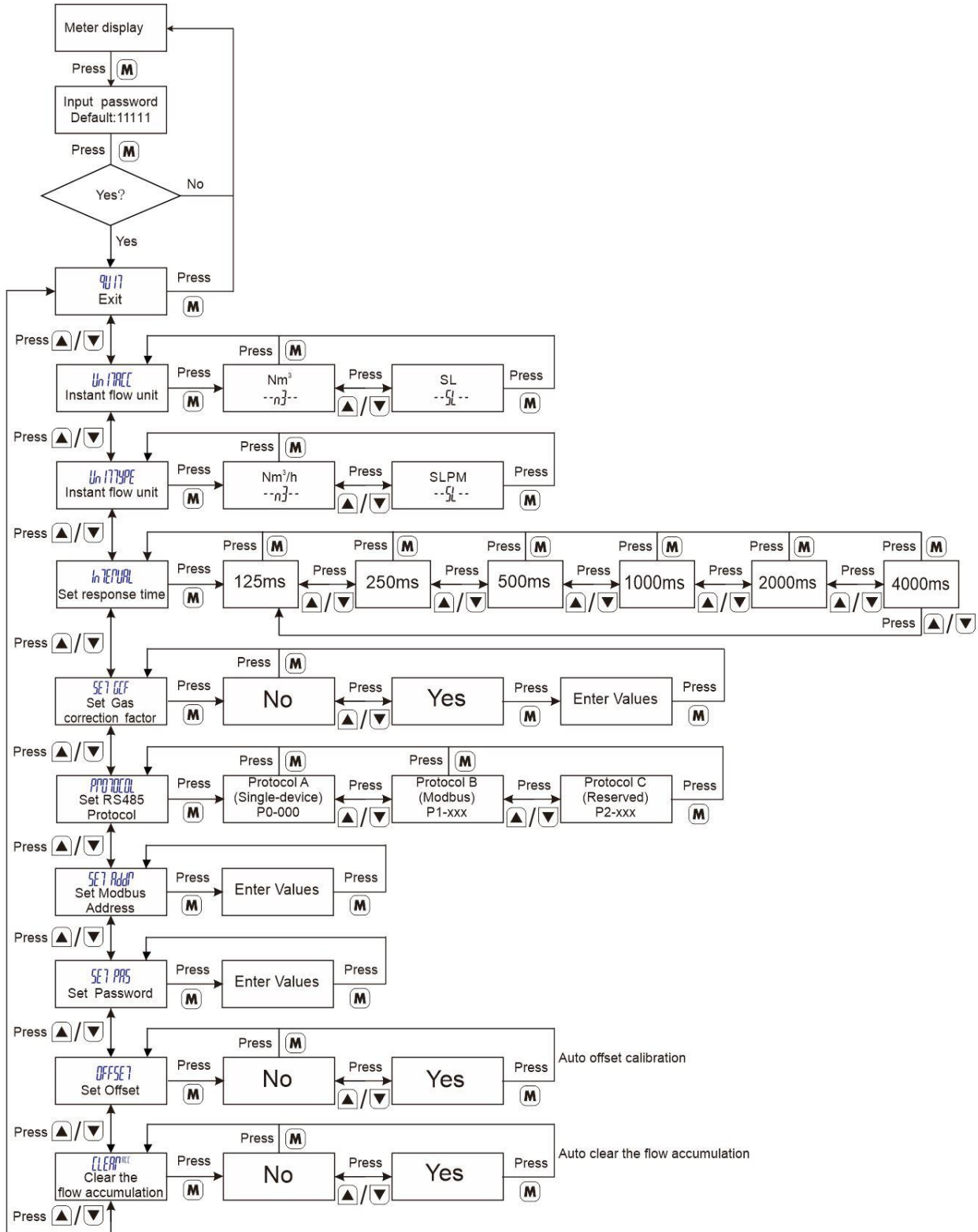

5.5. RS485 Modbus communication protocol (Mode P2)

The digital communication protocol Mode P2 is based on standard Modbus RTU Half-plex mode. A master (PC or PLC) can communicate with multiple slaves (the current product) for data exchange and communication parameter configuration. Refer to Table 3.3 for cable connection.

5.5.1. Hardware connection

The hardware layer is TIA/EIA-485-A, as illustrated below. In this configuration, the product (MF5600) is a slave.

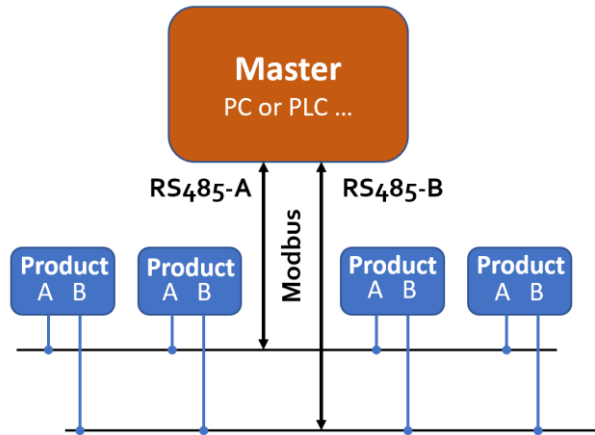

5.5.2. Communication parameters

The PC UART communication parameters are listed in the following table.

Parameters	Protocol
	RTU
Baud rate (Bits per second)	9600 bps
Start bits	1
Data bits	8
Stop bits	1
Even/Odd parity	None
Bits period	104.2 μ sec
Bytes period	1.1458 msec
Maximum data length	20
Maximum nodes	247

5.5.3. Frame

The frame function is based on the standard Modbus RTU framing:

Start_bits	Address	Function codes	Data	CRC	Stop_bits
T ₁ -T ₂ -T ₃ -T ₄	8 bit	8 bit	N 8 bit (20≥n≥0)	16 bit	T ₁ -T ₂ -T ₃ -T ₄

Start_bits: 4 periods bit time, for a new frame.

Address: The address can be set from 1 to 255 except for 157 (0x9d). 0 is the broadcast address.

Function codes: Define the product (MF5600)'s functions/actions (slaves), either execution or response.

Data: The address of the register, length of data, and the data themselves.

CRC: CRC verification code. The low byte is followed by the high byte. For example, a 16 bit CRC is divided into BYTE_H and BYTE_L. In the framing, the BYTE_L will come first, then followed by the BYTE_H. The last one is the STOP signal.

Stop_bits: 4 periods bit time, for ending the current frame.

5.5.4. Function codes

The Modbus function codes applied for the product are the sub-class of the standard Modbus function-codes. These codes are used to set or read the registers of the product:

Code	Name	Functions
0x03	Read register	Read register(s)
0x06	Set single register	Write one single 16-bit register
0x10	Set multiple registers	Write multiple registers

5.5.5. Registers

The product (MF5600) has multiple registers available for the assignment of the various functions. With these functions, the user can obtain the data from the products, such as *product address* and *flow rates* from the registers, or set the product functions by writing the corresponding parameters.

The currently available registers are listed in the following table, and the registers may be customized upon contact the manufacturer. Where R: read; W: write-only; W/R: read and write.

Note: At the time of shipping, the write protection function is enabled except for address and baud rate. Once the user completes the register value change, the write protection will be automatically enabled once again to prevent incidental data loss.

Functions	Description	Register	Modbus reference
Address	Product address (R/W)	0x0001	40001 (0x0001)
Flow rate	Current flow rate (R)	0x0002~0x0003	40002 (0x0002)
Totalizer	Totalizer or accumulated flow rate (R)	0x0004~0x0006	40004 (0x0004)
Communication mode	Gas correction factor (R/W)	0x0000	40000 (0x0000)

The detailed information of each register is described below: Y: enabled; N: disabled

Address	0x0001	Write	Y
		Read	Y
Description	Address of the product		
Value type	UNIT 16		
Notes	Values from 1 to 255 except for 157 (0x9d). 0 is the broadcast address.		

Flow rate	0x0002 ~ 0x0003	Write	N
		Read	Y
Description	Current flow rate		
Value type	UNIT 16		
Notes	Flow rate = [Value (0x0002)*65536 + value (0x0003)]/1000 e.g.: for a flow rate of 123.456 SLPM, the user will read "1 (0x0001)" from register 0x0002 and "57920 (0xE240)" from register 0x0003, therefore Current flow rate = (1*65536+57920)/1000 = 123.456		

Totalizer	0x0004 ~ 0x0006	Write	Y
		Read	Y
Description	Totalizer or accumulated flow rate		
Value type	UNIT 32 + UNIT 16		
Notes	A1 = Value (0x0004) * 65536 + Value (0x0005) A2 = Value (0x0006) Totalizer or accumulated flow rate = (A1 * 1000 + A2)/1000 e.g.: for a totalizer or accumulated flow rate of 3452.245 m ³ , the user will read "0 (0x0000)" from register 0x0004; "3452(0xD7C)" from register 0x0005, and "245(0x00F5)" from register 0x0006. Then, the totalizer or accumulated flow rate = ((0 + 3452)*1000 + 245)/1000=3452.245.		

Communication mode	0x0000	Write	Y
		Read	Y
Description	Communication mode		
Value type	UNIT 16		
Notes	Value=0, factory mode; Value=1 RS485 Modbus.		

5.6. Analog output

5.6.1. 4~20mA output

The loop resistor connection is illustrated below. The current output load depends on the power supply (the yellow area in the graph). The maximum load resistor, R_L , with a 24Vdc supply, will be 850Ohm.

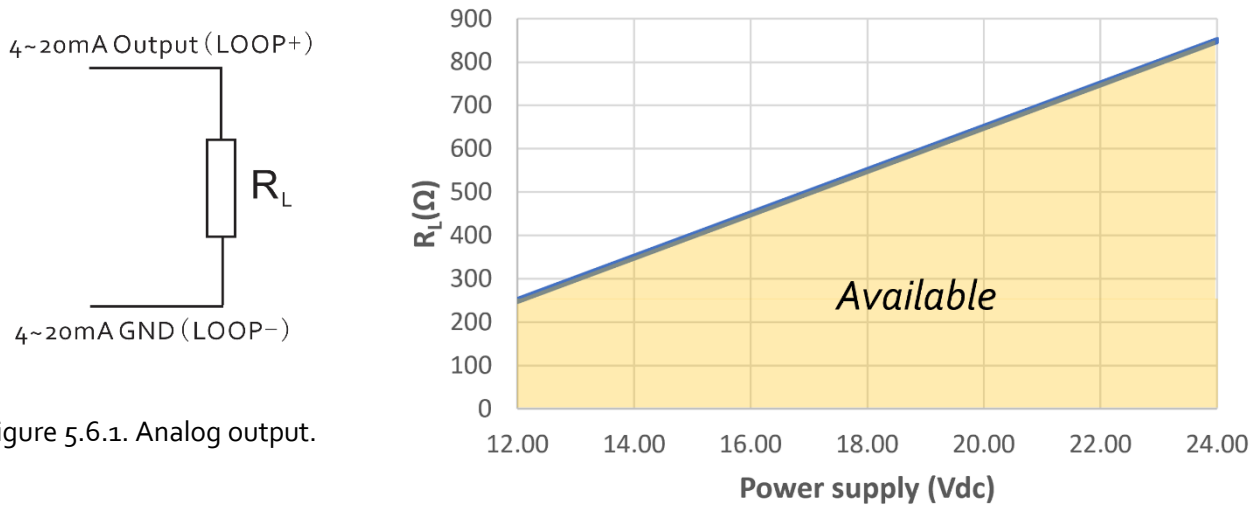

Figure 5.6.1. Analog output.

5.6.2. Pulse output

The pulse output for the accumulated flow rate is an even square wave having 3.3 Vdc high and 0 Vdc low. The pulse can be programmed to 0.01 SL, 0.1 SL, 1 SL or 10L/pulse. The default value is 1.00 SL/pulse.

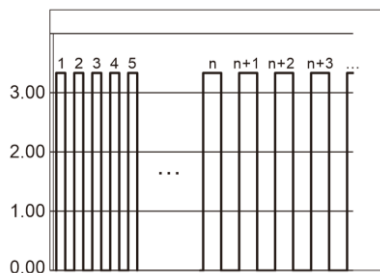

Figure 5.6.2. Pulse output for accumulated flow rate.

6. Product selection and order information

6.1. Product selection

The product part number is composed of the product model number and suffixes indicating the full-scale flow rate, as well as the other parameters. Refer to the following for details.

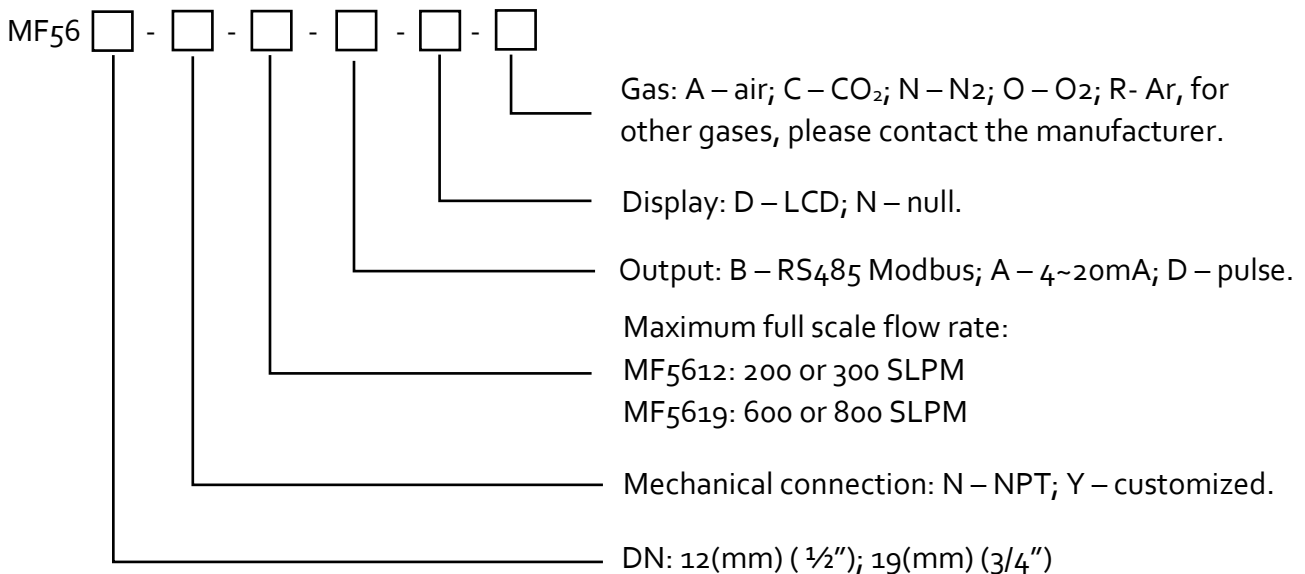

Table 6.1.1. Unite conversion table (Examples)

Model	DN (mm)	DN (")	Maximum full-scale flow rate		
			SLPM	SCFH	NCMH
MF5612	12.0	1/2"	200	7	12
			300	11	18
MF5619	19.0	3/4"	600	21	36
			800	28	48

6.2. Order contact and customer support

The sales offices and the sales distributors/representatives are listed at the end of this document. For small quantities, the order can be placed either through the Siargo website: www.siargo.com or the sales office. For large quantities, please contact the sales office, distributors, or sales representatives.

Siargo is making every effort to ensure the quality of the products. In case of questions and/or product supports, please contact the customer service listed at the end of the document.

7. Technical specifications

All specifications listed in the following table unless otherwise noted apply for calibration conditions at 20°C and 101.325 kPa absolute pressure with air. The product is horizontally mounted at calibration.

	Value	Unit
Full-scale flow range	200 / 300 (MF5612) ; 600 / 800 (MF5619)	SLPM
Accuracy	$\pm(1.5+0.20FS)$	%
Repeatability	0.5	%
Turn-down ratio	30:1 (100:1 customizable)	
Response time	<200	msec
Working temperature	-10~55	°C
Maximum pressure	1.0	MPa
Humidity	<95, no condensation	%RH
Power supply	12~24 (50 mA)	Vdc
Cable	Power/data cable; detachable LCD cable.	
Digital output	RS485 Modbus half-duplex / 4~20 mA / Pulse	
MENU access	3 key – front face keyboard/digital	
Display	Detachable LCD: instant flow rate, totalizer, or accumulated flow rate	
Mechanical connection	NPT or customized	
Storage temperature	-20 ~ 70	°C
Reference conditions	20°C, 101.325 kPa, air	
Weight	1.62 (MF5612); 2.05 (MF5619)	kg
Fluid compatibility	Non-corrosive	
CE	EN61326-1; -2; -3	

Note: For other features or specifications not listed, please contact the manufacturer.

8. Technical notes for the product performance

8.1. Measurement principle

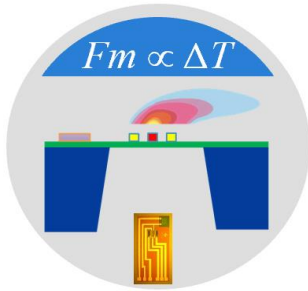

Figure 8.1. Measurement approach illustration.

The products utilize the Company's proprietary micro-machined (MEMS) calorimetric sensing and data process technology. A thermal signal generator with a pair of sensing elements at the up and downstream of the microheater is precisely manufactured and separated at predefined micrometer distances on a chip surface with excellent thermal isolation. When a fluid is flowing through the sensing chip, the fluid carries the thermal signal downstream. The sensing elements register the temperature differences, further correlated to the fluid mass flow rate via the calibration process.

The calorimetric sensing approach offers a large dynamic range with a better performance against the environmental parameter alternations.

Please refer to the company's US patents and other publications made available to the public for additional information.

8.2. Precautions for the best performance of the product

8.2.1. Comparison with a third party reference meter

It is very common that a user may compare the data from the product with a third-party reference meter, and in many cases, there could be some discrepancies.

When performing such a comparison, please note that the reference meter should have a better-specified accuracy (about 1/3 of the product), and pay special attention to the differences in the reading accuracy and full-scale accuracy.

A full scale accuracy = reading accuracy x (full scale flow rate/ set point (current) flow rate)

Another key point to compare the different flow meter is that as long as the fluidic flow is a continuous flow without pulsation, then the fluidic dynamic will have the system following the Bernoulli equation:

$$P_1 + \frac{1}{2}\rho v_1^2 + \rho g h_1 = P_2 + \frac{1}{2}\rho v_2^2 + \rho g h_2$$

where ρ is the fluid density; g is the acceleration due to gravity; P_1 is the pressure of the reference meter; P_2 is the pressure at the test meter; v_1 is the velocity of the reference meter, and v_2 is the velocity of the test meter. h_1 and h_2 are the corresponding height for the meters which in most cases is the same in the system. Therefore, it would be very critical to have the system does not have a pressure variation. (This explains our recommendations for the installations in Section 4). Also, the meter measurement principle is often very important for the understanding of any discrepancies.

8.2.2. Particle contamination and fluidic cleanness

Any contamination including particles and liquid vapors would be detrimental to the accuracy of the flow measurement and also to the meter functionality. It is important to ensure the applied flow medium will be clean and dry. If any contamination is suspected, please allow experienced technical personnel to have it checked and re-conditioned. Do not use a foreign cleanser or other fluids to clean the flow path which could bring irrecoverable damage.

8.2.3. Apply to a different gas medium

The product is calibrated with a high precision NIST traceable metrological standard with clean and dry air. In case the meter will be applied to meter the other clean and dry gas, a correct gas conversion factor needs to be registered into the meter before the measurement.

The meter operates similar to the principle described in the international standard for thermal mass flow meters (ISO 14511:2001 - Measurement of fluid flow in closed conduits — Thermal mass flowmeters). Due to the meter assembled procedure, the head loss value from the meter to the meter would not be 100% identical, and at the large dynamic measurement range, the thermal response would also have some deviations and nonlinearity from gas to gas. Therefore, measurement by the meter for a gas medium other than the calibration gas would bear larger measurement errors, particularly at the low Reynold number range where the laminar flow has a sensitive flow profile.

9. Troubleshooting

Phenomena	Possible causes	Actions
No signal / display	Power not connected; battery empty	Connect the power, check the cable
	Cable connection incorrect	Check cable
	No flow or clogging	Check flow and contamination
	Power regulator failure	Return to factory
	Sensor failure	Return to factory
Large errors or unexpected flow rate	Particles, fluid type	Check system
Erroneous or large noise	Vibration, unstable flow	Check system
Valve not work	Wire connection, valve	Return to factory
Offset unstable	Circuitry instability	Check system, power off
No digital interface	Wrong address, software	Check commands, connection
No wireless, BT cannot pair	Wrong model, data jam	Check model, power off/on

10. Warranty and Liability

(Effective January 2018)

Siargo warrants the products sold hereunder, properly used, and properly installed under normal circumstances and service. As described in this user manual, it shall be free from faulty materials or workmanship for 180 days for OEM products and 365 days for non-OEM products from the date of shipment. This warranty period is inclusive of any statutory warranty. Any repair or replacement serviced product shall bear the same terms in this warranty.

Siargo makes no warranty, representation, or guarantee and shall not assume any liability regarding the suitability of the products described in this manual for any purposes that are not specified in this manual. The users shall be held for full responsibility for validating the performance and suitability of the products for their particular design and applications. For any of the misuse of the products out of the scope described herein, the user shall indemnify and hold Siargo and its officers, employees, subsidiaries, affiliates, and sales channels harmless against all claims, costs, damages, and expense or reasonable attorney fee from direct or indirect sources.

Siargo makes no other warranty, express or implied, and assumes no liability for any special or incidental damage or charges, including but not limited to any damages or charges due to installation, dismantling, reinstallation, etc. other consequential or indirect damages of any kind. To the extent permitted by law, the exclusive remedy of the user or purchaser, and the limit of Siargo's liability for any and all losses, injuries, or damages concerning the products, including claims based on contract, negligence, tort, strict liability, or otherwise shall be the return of products to Siargo, and upon verification of Siargo to prove to be defective, at its sole option, to refund, repair or replacement of the products. Regardless of form, no action may be brought against Siargo more than 365 days after a cause of action has accrued. The products returned under warranty to Siargo shall be at the user or purchaser's risk of loss and will be returned, if at all, at Siargo's risk of loss. Purchasers or users are deemed to have accepted this limitation of warranty and liability, which contains the complete and exclusive limited warranty of Siargo. It shall not be amended, modified, or its terms waived except by Siargo's sole action.

This manual's product information is believed to be accurate and reliable at the time of release to or made available to the users. However, Siargo shall assume no responsibility for any inaccuracies and/or errors and reserves the right to make changes without further notice for the relevant information herein.

This warranty is subject to the following exclusions:

- (1) Products that have been altered, modified, or have been subject to unusual physical or electrical circumstances indicated but not limited to those stated in this document or any other actions which cannot be deemed as proper use of the products;

- (2) Products that have been subject to chemical attacks, including exposure to corrosive substances or contaminants. In the case of battery usage, long term discharge or leakage induced damages;
- (3) Products that have been opened or dismantled for whatever reasons;
- (4) Products that have been subject to working conditions beyond the technical specification as described by this manual or related datasheet published by the manufacturer;
- (5) Any damages incurred by the incorrect usage of the products;
- (6) Siargo does not provide any warranty on finished goods manufactured by others. Only the original manufacturer's warranty applies;
- (7) Products that are re-sold by unauthorized dealers or any third parties.

11. Service contact

Siargo Ltd. is making every effort to ensure the quality of the products. In case of questions, and or product supports, please contact customer service at the address listed below. We will respond to your request in a timely fashion and will work with you toward your complete satisfaction.

Customer service and all orders should be addressed to

Siargo Ltd.
3100 De La Cruz Boulevard, Suite 210,
Santa Clara, California 95054, USA
Phone: +01(408)969-0368
Email: info@Siargo.com

For orders, please provide an accurate and full postal address. Siargo will not ship to P.O. Boxes or via a third party.

For further information and updates, please visit www.Siargo.com.

Appendix I: Product evaluation kit

Siargo offers a product evaluation kit, including a digital data converter, USB data cable, and a User Application software, that allows the user to evaluate the product performance on a Microsoft Windows-based computer. For some simple applications with digital data transfer, this kit could serve the purpose. The user can read and visualize the flow rate of the product, obtain the totalizer or accumulated flow rate values, and save the data for further analysis. It can read from up to 128 sensors with the RS485 interface in serial.

For further information and purchase of the evaluation kit, please contact the manufacturer or the sales representative.

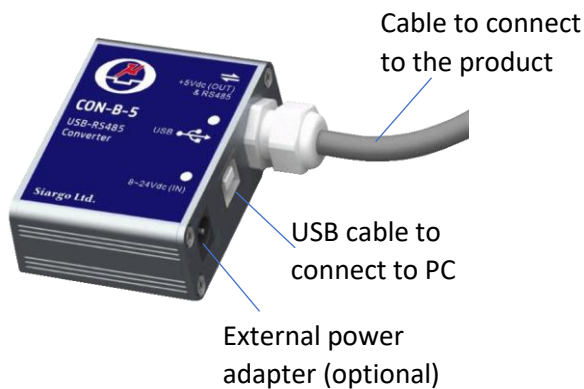

Each converter has a fixed cable that can be directly connected to the product. The USB cable connected to the PC is also included.

For most of the product, the power from the PC via the USB cable will be sufficient to power the sensor product, no external power will be required. However, for multiple sensors in serial, the power via the USB cable may not be enough, an external power adapter with 8~24Vdc will be required.

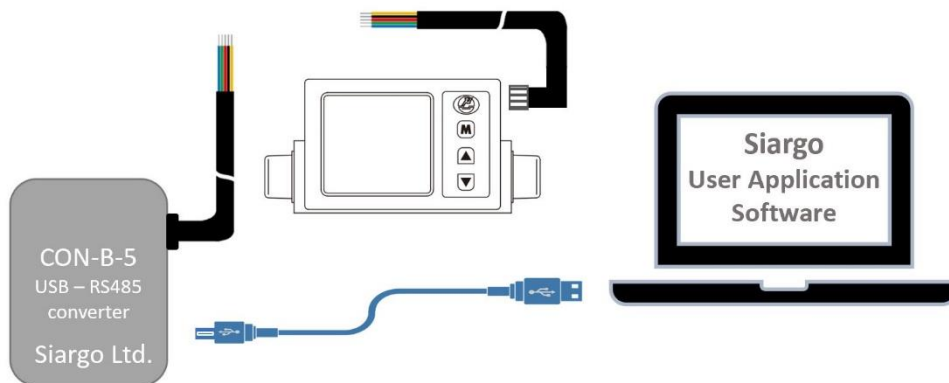

Appendix II: Document history

Revision C.1 (March 2021)

Reformat, corrections, add the evaluation kit.

Revision B.3 (July 2018):

Add the RS485 Modbus Protocol (7.RS485 Modbus Protocol (Mode P2)).

Revision B.2 (April 2018):

Updated the Function button (Fun) to Menu button (M).

Revision B.1 (July 2017):

Corrected the pulse output setting (6.5 Pulse Output);

Added the revision history (Appendix).



SMERI s.r.l.

I 20057 Assago (MI) - Via Mario Idiomi 3/13

Tel: +39 02 5398941

E-mail: smeri@smeri.com - www.smeri.com

