



# Gas Mass Flow Meter VE.2.01

## Model MF5000

# Gas Mass Flow Meter

with MEMS calorimetric sensing technology

MF5000 Series

## User Manual

Document No. 07-2022-M7 EN

Issue date: 2022.07

Revision: VE.2.01

### Siargo Ltd.

3100 De La Cruz Boulevard, Suite 210

Santa Clara, CA 95054

USA

Tel: +1(408)969.0368

Email: [info@siargo.com](mailto:info@siargo.com)

© Copyright 2022 by Siargo Ltd.

Siargo Ltd. and its subsidiaries reserve the right to change the specifications and/or descriptions without prior notice. For further information and updates, please visit: [www.Siargo.com](http://www.Siargo.com)

 **Attention!**

- Please carefully read this manual prior to operating this product.
- Do not open or modify any hardware which may lead to irrecoverable damage.
- Do not use this product if you suspect any malfunctions or deflection.
- Do not use this product for corrosive media or in a strong vibration environment.
- Use this product according to the specified parameters.
- Only the trained or qualified personnel shall be allowed to perform product services.

 **Use with caution!**

- Be cautious for the electrical safety, even it operates at a low voltage, any electrical shock might lead to some unexpected damages.
- The gas to be measured should be clean and free of particles. Do not apply this meter for liquid medium.
- Do not apply for any unknown or non-specified gases that may damage the product.
- For remote data, please be sure the meter is properly configured.

## Table of Contents

<b>1. Overview</b> .....	<b>5</b>
<b>2. Receipt / unpack of the products</b> .....	<b>6</b>
<b>3. Knowing the products</b> .....	<b>7</b>
3.1. Product description .....	7
3.2. LCD description.....	7
3.3. Power and data cable description .....	8
3.4. Mechanical dimensions.....	9
<b>4. Installation</b> .....	<b>10</b>
<b>5. Operation and MENU description</b> .....	<b>13</b>
5.1 Check the product specifications .....	13
5.2 Check the leakage .....	13
5.3 Power the meter and digital data connection .....	13
5.4 Meter MENU descriptions .....	14
5.4.1 Starting the measurement.....	14
5.4.2 MENU entry with a verified password .....	15
5.4.3 Set the RS485 Modbus address .....	15
5.4.4 Set the RS485 communication baud rate .....	16
5.4.5 Reset or calibrate the offset.....	16
5.4.6 Gas conversion factor (GCF) for different gas measurement .....	17
5.4.7 Set the 2nd-correction factor .....	18
5.4.8 Set the Response time.....	18
5.4.9 Set the unit for the accumulated or totalized flow rate .....	19
5.4.10 Set the unit for the instant flow rate .....	19
5.4.11 Change the default password .....	20
5.4.12 Reset the accumulated or totalized flow rate.....	20
5.4.13 Reset the 2nd-correction factor .....	21
5.4.14 Exit the MENU.....	21
5.4.15 MENU key sequence for the settings.....	22
5.5 RS485 Modbus communication protocol .....	22

5.5.1	Hardware connection .....	23
5.5.2	Communication parameters.....	23
5.5.3	Frame .....	24
5.5.4	Function codes .....	24
5.5.5	Registers.....	24
5.6	Analog (4 ~ 20 mA) output .....	28
6.	Product selection .....	29
7.	Technical specifications.....	30
7.1	Specifications .....	30
7.2	Pressure loss .....	31
8.	Technical notes for the product performance .....	34
8.1	Measurement principle .....	34
8.2	Precautions for the best performance of the product .....	34
8.2.1	Comparison with a third party reference meter.....	34
8.2.2	Particle contamination and fluidic cleanness .....	35
8.2.3	Apply to a different gas medium.....	35
9.	Troubleshooting .....	36
10.	Warranty and Liability.....	37
11.	Service contact .....	39
	Appendix I: Product evaluation kit.....	40
	Appendix II: Document history .....	41

## 1. Overview

All contact information can be found at the end of this manual.

This manual provides essential information for the operation of the 3<sup>rd</sup> generation of the MF5000 series of gas mass flow meters for general-purpose gas metrology. The product performance, maintenance, and trouble-shooting as well as the information for product order, technical support, and repair are also included.

MF5000 mass flow meters are designed for general purpose precise industrial gas measurement, monitor, or control. The meter series cover a wide dynamic flow range with a working pressure rating of up to 1.5MPa, and a temperature ranging from -20 to 60°C.

The meters are operated with Siargo's proprietary MEMS calorimetric mass flow sensors together with the smart control electronics. The sensor surface is passivated with silicon nitride ceramic materials and with a water/oil proof nano-coating for performance and reliability. The meter body is made of stainless steel SUS 304 that is ready for application of most gases.

This new release boosts the protection class to IP66 and offers additional mechanical connection flexibility with both male and female connectors which can be further adapted with any other threaded ones. The electrical interface is changed from DB9 to M12 for better protection.

## 2. Receipt / unpack of the products

Upon receipt of the products, please check the packing box before the dismantlement of the packing materials. Ensure no damages during shipping. If any abnormality is observed, please contact and notify the carrier who shipped the product and inform the distributors or sales representatives if the order is not placed directly with the manufacturer, otherwise, the manufacturer should be informed as well. For any further actions, please refer to the return and repair section in this manual.

If the packing box is intact, proceed to open the packing box, and you shall find the product (either the meter or the meter with the valve per the actual order). The power adapter and/or data cable as shown below may also be found according to your actual order.

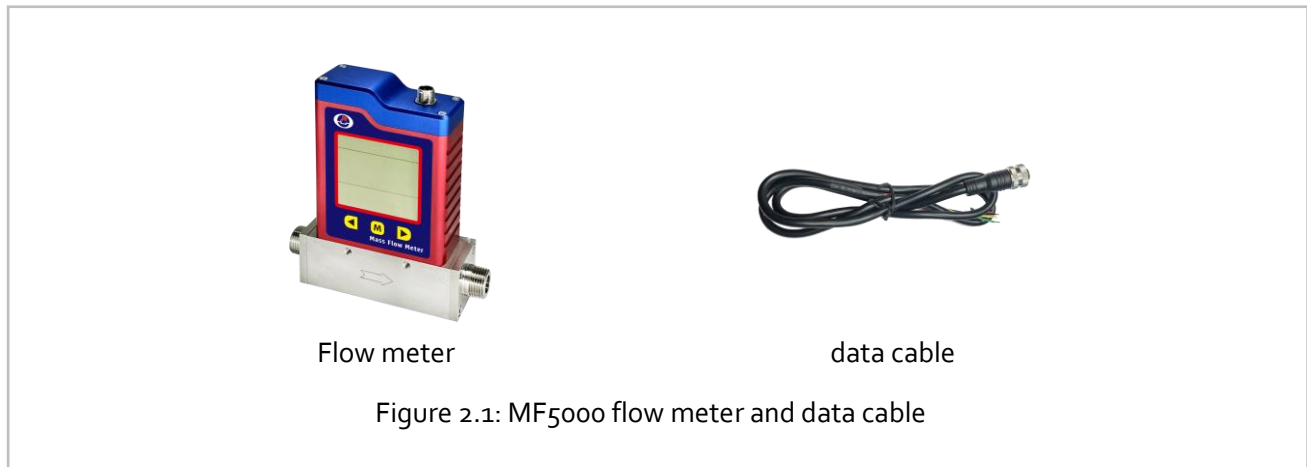

Please check immediately for the integrity of the product as well as the power and data cable, if any abnormal is identified, please notify the distributor/sales representative or manufacturer as soon as you can. If any defects are confirmed, an exchange shall be arranged immediately via the original sales channel. (Note: the LCD screen shall not be lighted until the power cable is plugged in). This user manual shall also either be included in the packing box or via an online request for an electronic version. In most cases, this manual shall be made available to the customer before the actual order.

The cable is a standard one with an M12 connector.

### 3. Knowing the products

#### 3.1. Product description

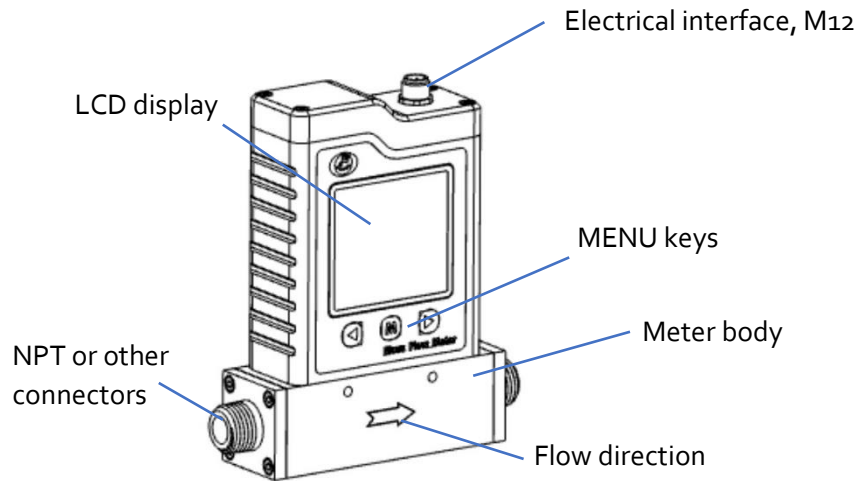

Figure 3.1: MF5000 parts description

#### 3.2. CD description

USER		20.0°C P 101.32kPa
Total 88888888.8888 Nm <sup>3</sup>	Total E1 E2 E3 E4 E5 0.0000 Nm <sup>3</sup>	Total 0.0000 Nm <sup>3</sup>
Flowrate 8888888.8888 SLPM	Flowrate 0.0000 SLPM	Flowrate 0.0000 SLPM

Figure 3.2: LCD symbol illustration.

The LCD provides all information that the product measures. Some symbols are reserved for future upgrades, and will not be lighted during the operation. The following table details the meaning of each of the symbols.

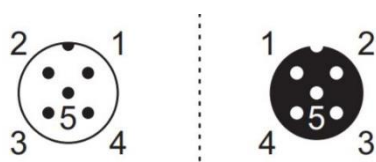

Table 3.1: Symbols description

<b>USER</b>	The top row only displays when communication or other user-defined function is in process.
<b>Total</b>	The middle row displays the accumulated or totalized flow rate in Nm <sup>3</sup> (Normalized cubic meters) or SCF (Standard cubic feet). Here the standard (normalized) conditions refer to 20°C, 101.325kPa.
<b>Flowrate</b>	The bottom row displays the instant flow rate in SLPM (Standard liters per minute), Nm <sup>3</sup> /h (Normalized cubic meters per hour), or SCFM (Standard cubic feet per minute)
<b>E1</b>	Error 1 – Sensor error
<b>E2</b>	Error 2 – ADC error
<b>E3</b>	Error 3 – RTC error
<b>E4</b>	Error 4 – EEPROM error
<b>E5</b>	Error 5 – Oscillator (crystal) error
	Temperature, for models with temperature option
<b>P</b>	Pressure, for models with pressure option

**\*Note:** Both the pressure and temperature sensors can be integrated with the current product but not with the default models. Please contact the manufacturer for further information.

### 3.3. Power and data cable description



Socket

Cable

Figure 3.3: MF5000 socket and cable

Table 3.2: MF5000 wire (M12) assignments.

Wire	Color	Definition
1	Brown	12 ~ 24 Vdc
2	White	RS485 B (-)
3	Blue	GND, common ground
4	Black	RS485 A (+)
5	Gray	4 ~ 20mA output

### 3.4. Mechanical dimensions

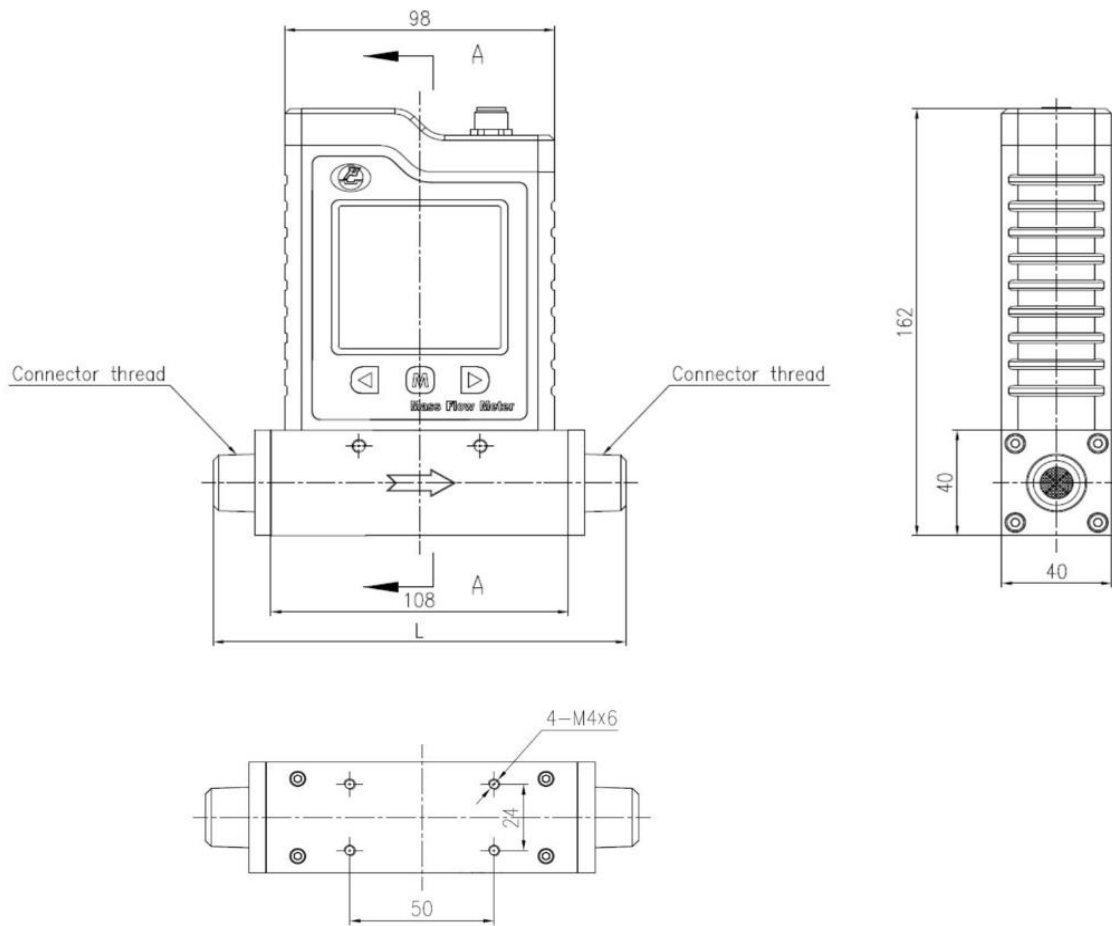

Figure 3.4: MF5000 meter dimensions

Model	DN (mm)	D (NPTM)	L
MF5003	3	1/8"	138
MF5006	6	1/4"	144
MF5008	8	3/8"	144
MF5012	12	1/2"	150
MF5019	19	3/4"	182.5

## 4. Installation

Do not open or alter any part of the product which would lead to malfunction and irrecoverable damage. It will also forfeit the terms of the warranty and cause liability.

The product at the time of shipment is fully inspected for its quality and meets all safety requirements. Additional safety measures during the installation should be applied. This includes, but is not limited to the leakage verification procedures, standard EDS (electrostatic discharge) precautions, and DC voltage precautions. Other tasks such as calibration, part replacement, repair, and maintenance must only be performed by trained personnel. Upon request, the manufacturer will provide necessary technical support and/or training for the personnel.

The product is preferable to be installed horizontally. Flow direction should be aligned with the arrow mark on the meter body. If the flowing fluid may have particles or debris, a filter is strongly recommended to be installed upstream of the meter.

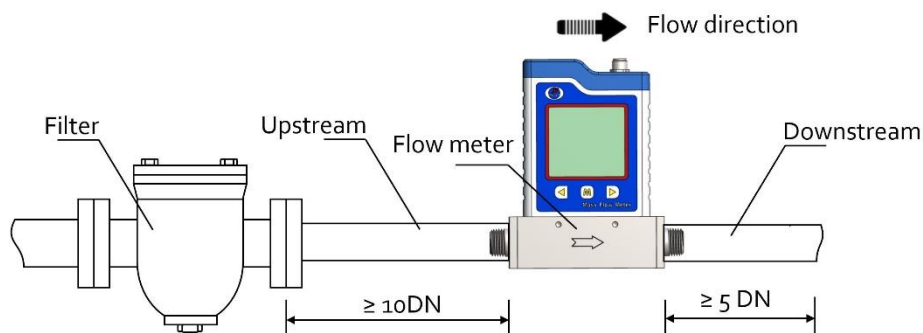

Figure 4.1: MF5000 meter installation

Please follow the following steps to complete the installation:

- a) Upon opening the package, the product's physical integrity should be inspected to ensure no visual damage.
- b) Before installation of the product, please ensure that the pipe debris or particles or any other foreign materials are completely removed.
- c) Cautions during installation:
  - i) It is preferable to first install/connect the meter inlet and then the outlet end of the meter; To ensure the measurement accuracy, an upstream straight pipe of length no less than 10DN and a downstream straight pipe of length no less than 5DN should be in place. Please refer to the following recommended installation configuration.

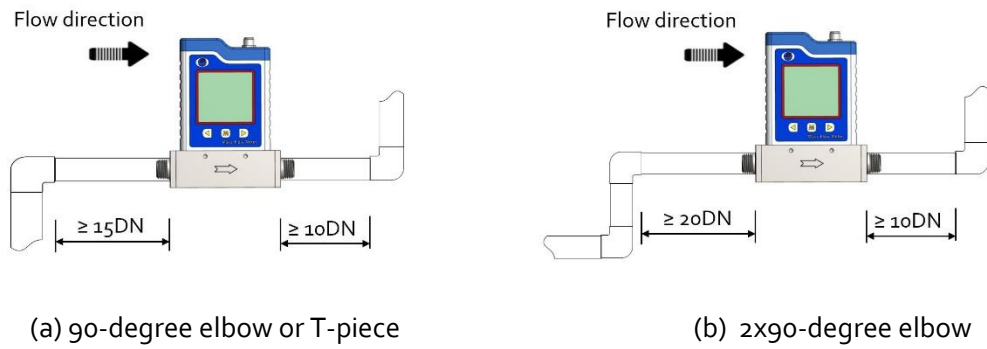

Figure 4.2: MF5000 meter installation

(ii) If the upstream or downstream pipe size is different from that of the product, the size of the installation line pipe diameter(s) should be larger than the flow channel (pipe) size of the meters to be installed. For some typical situations, please follow the installation recommendation detailed in the following sketches.

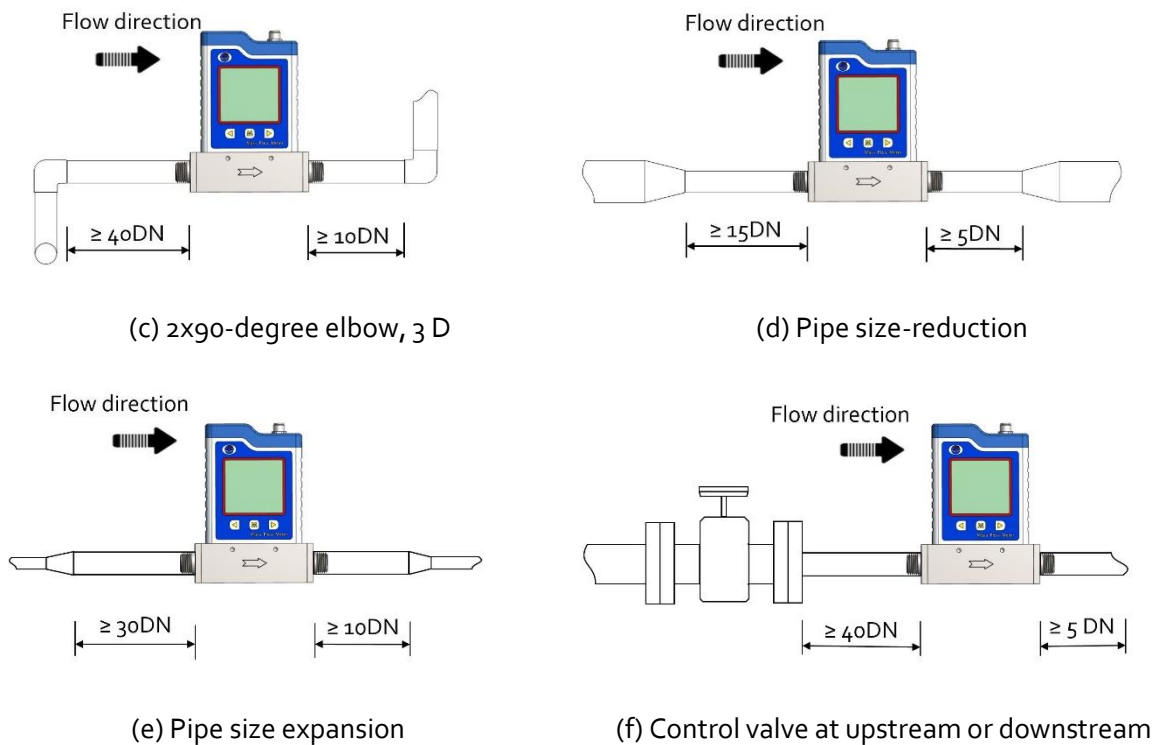

Figure 4.3: MF5000 meter installation

(iii) During installation, please make sure no foreign materials (such as water, oil, dirt, particles, etc.) enter the installation pipeline.

- d) Connect electrical wires per the wire definition in Table 3.3. Please be sure of the power supply range (i.e., 12 ~ 24 VDC) and power supply polarization. If an adapter is other than the one supplied by the manufacturer, make sure the adapter meets industrial standards and has all safety certifications.
- e) For the data communication wire connection, please follow the description in Table 3.3 and make sure that the wires are correctly connected to the proper ports on your data device/equipment. Please make sure the data cable meets industrial standards with proper shielding.
- f) Once the external power is successfully connected, the LCD should be lighted up with the proper information displayed to work correctly.
- g) Slowly open the valve(s) if any, upstream or downstream or both of the pipeline, and the meter should then start to measure the flow in the pipeline. Note: because the meter has a large dynamical measurement range, it could be normal if you see the small instant flow rate before you open the valve as there could be some leakage. However, make sure the meter reads null when there is no flow present in the pipeline.
- h) This will conclude the installation.



### Cautions

- a) Don't alter any parts of the product.
- b) Ensure the electrical connection is properly done per the instructions.
- c) Make sure no mechanical stresses in the connections.
- d) The strong electromagnetic interference sources close by or any mechanical shocks at the pipeline may also create malfunctioning of the product.
- e) Slowly open/close valves to prevent abrupt pulse flow impact.

## 5. Operation and MENU description

### 5.1 Check the product specifications

Before starting to use this product, check the product specifications that can be found in this manual or the basic information located on the back panel of the product.

The detailed product technical specifications can be found in Section 7. For a specific application, the pressure rating must not be higher than the system pressure to be measured, and the flow range should also be within the specified ones. In most cases, the use of a high full-scale ranged meter for the very low flow rate measurement often results in erroneous data. The gas to be measured must also be consistent with that specified by the product. Be particularly cautious about the supplied voltage indicated in the specification. A higher voltage may lead to irrecoverable damage, and a lower voltage will not power the product for any desired functions.

For the best performance of the product, it is advised that the gas to be measured must be clean and free of particles or other foreign materials.

### 5.2 Check the leakage

Check gas leakage before any measurement. If it is needed, pressurized nitrogen or air can be used for the leakage check.

### 5.3 Power the meter and digital data connection

Although this product complies with the CE-required EMC regulations, it also requires the product to be used according to the standard electrical device practice. Before connecting the meter with external DC power or an AC-DC adapter, make sure the supply voltage is within the range of the specified ones in Section 7. Be cautious that the standard electrical device precautions such as EDS (electrostatic discharge) and DC voltage are observed. Excessive electrostatic discharge may damage the product.

The manufacturer-supplied power and data cable have a locking fixture. Lock the cable and make sure it is properly engaging and will not be accidentally got unplugged.

Half-duplex RS485 Modbus is used for digital data communication. Make sure the wires are properly connected to the receiver side.

### 5.4 Meter MENU descriptions

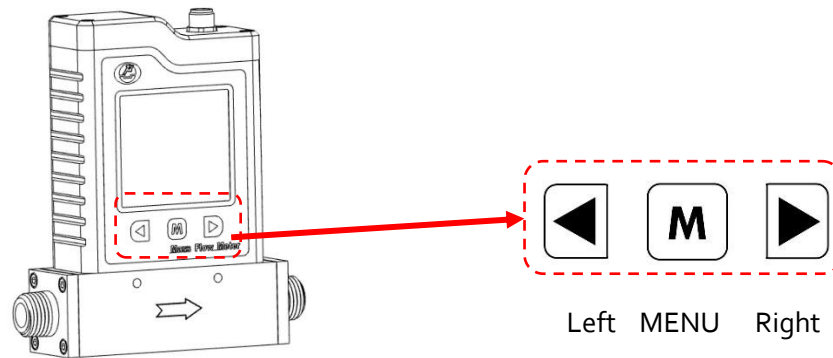

Figure 5.1: MF5000 keyboard

The meter has a front 3-key keyboard for the user to set the desired functions, access data, and check the status. The Menu key (M) is at the central position that allows the user to select a function and confirmation or other related actions that will be detailed below. Two keys (“Left” and “Right”) to select the menu and sub-menu.

#### 5.4.1 Starting the measurement

Once the power is supplied and no abnormal issues are observed, the meter is ready to perform the measurements. The default display is for the mass flow measurement having two numerical lines on the LCD. The middle line is the accumulated or totalized flow rate, and the lower line is the instant flow rate. The upper line will light up when the pressure or temperature option is selected.

The display characters are limited by the LCD capability, the following table is the illustration.

A	b	C	d	E	F	G	H	I	J	K	L	^	n	o	P	q	r
A/a	B/b	C/c	D/d	E/e	F/f	G/g	H/h	I/i	J/j	K/k	L/l	M/m	N/n	O/o	P/p	Q/q	R/r
S	T	U	V	W	X	Y	Z	1	2	3	4	5	6	7	8	9	0
S/s	T/t	U/u	V/v	W/w	X/x	Y/y	Z/z	1	2	3	4	5	6	7	8	9	0

### 5.4.2 MENU entry with a verified password



At the flow measurement (main) display, press the central "M" MENU key, it will enter into the password setting and verification MENU. The default password is "11111". If the password is incorrect, the display will return to the main display.

To enter a new password, press the "Up" or "Down" key to change the digit that flashes, and press the "M" key to confirm. Repeat this process for all 5 digits and the meter will enter into the menu setting interfaces/screen.

Subsequently, the MENU allows the user to:

- |   |             |
|---|-------------|
| ➤ Set Modbus address                                      | F2 - Addr   |
| ➤ Change communication baud rate                          | F3 - bPS    |
| ➤ Reset or calibrate the offset                           | F11 - oFFST |
| ➤ Enter the gas conversion factor (GCF)                   | F12 - GCF   |
| ➤ Set the 2 <sup>nd</sup> -correction factor              | F14 - Corr  |
| ➤ Change the response time                                | F16 - rESPS |
| ➤ Set the unit for the accumulated or totalized flow rate | F31 - UnT-A |
| ➤ Set the unit for the instant flow rate                  | F32 - UnT-F |
| ➤ Change the default password                             | F91 - PASS  |
| ➤ Clear or reset the accumulated or totalized flow rate   | F92 - CLr-A |
| ➤ Reset the 2 <sup>nd</sup> -correction factor            | F94 - rS2nd |
| ➤ Exit from the MENU                                      | F99 - qUIT  |

**Note:** During this process, the meter will continue to measure the flow without being interrupted.

### 5.4.3 Set the RS485 Modbus address

After the password is verified and entered into the MENU settings, press the "Up" or "Down" key until the screen shows the F2 - Addr as indicated to the left.



The Modbus address has 3 digits, which can be any number between 001 to 255. Press the "M" key to enter into the change address screen. Press the "Up" or "Down" key to change the flashing digits, and then press the "M" key to confirm. After the address is set, the display will return to F2 - Addr, which indicates the task is completed. Press the "Up" or "Down" key to select F99 - qUIT and the "M" key to exit the MENU and return to the Main Display screen.



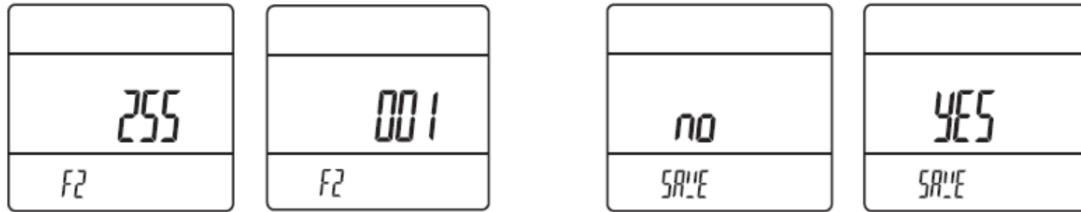

#### 5.4.4 Set the RS485 communication baud rate

Following the above-mentioned steps, at the MENU setting screen, use the "Up" or "Down" key to select F3 - bPS and then press the "M" key to set the RS485 communication baud rate.

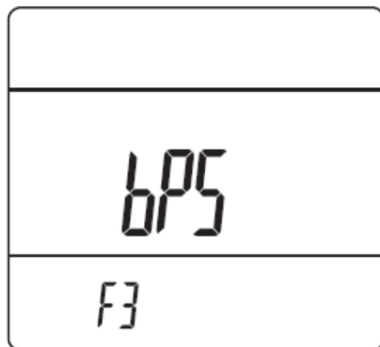

There are 6 baud rates selectable, depending on your system requirements: 4800, 9600, 19200, 38400, 57600, and 115200. The default baud rate is 9600. Use the "Up" or "Down" key to select the desired one and press the "M" key to confirm. The display will then return to the F3 - bPS screen, which indicates the task is completed. Use the "Up" or "Down" key to select F99 - qUIT and the "M" key to exit the MENU and return to the Main Display screen.

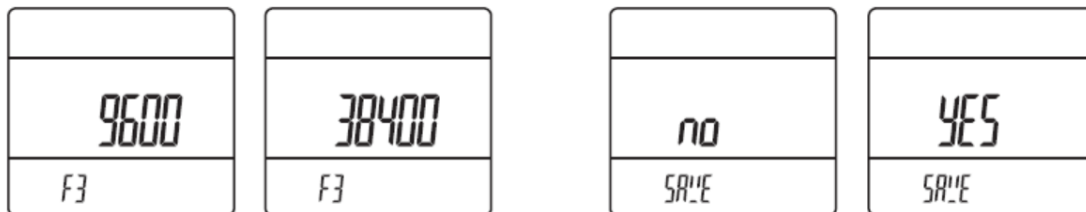

#### 5.4.5 Reset or calibrate the offset

After a certain time of usage, the meter's offset (zero flow rate) might or might not have a small shift. Or when you apply the meter for different gases, the offset might be shifted. To ensure measurement accuracy, it is necessary to reset or calibrate the offset. Following the above-

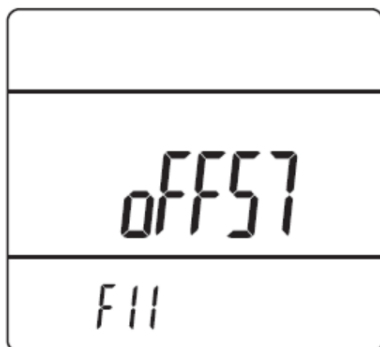

mentioned steps, at the MENU setting screen, use the "Up" or "Down" key to select F11 - offST. Before performing the task, make sure there is absolutely no flow in the flow channel, otherwise, it will create even bigger erroneous measurement results.

Press the "M" key to confirm the task, and it will open the sub-MENU asking you to confirm. Use the "Up" or "Down" key to select the desired one and press the "M" key to confirm. The display will then return to the F11 - offST screen, which indicates the task is

completed. Use the "Up" or "Down" key to select F99 - qUIT and the "M" key to exit the MENU and return to the Main Display screen.



### 5.4.6 Gas conversion factor (GCF) for different gas measurement

For the general purpose of the application, a gas conversion factor (GCF) can be applied to meter the gas different from the default one or the one used for calibration. The GCF is determined by the thermal calorimetric sensing principle as well as the meter fluidic dynamic design and the control circuitry. Contact the manufacturer to obtain the values corresponding to the correct models.

The GCF for air is 1000.

**Note: If the meter during purchase is ordered for a special real gas calibration, contact the manufacturer before further proceeding.**

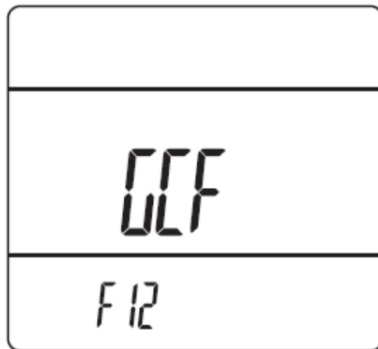

Following the above-mentioned steps, at the MENU setting screen, use the "Up" or "Down" key to select F12 - GCF. Press the "M" key to confirm, and it will open the sub-MENU showing the current gas conversion value. Use the "Up" or "Down" and the "M" confirming key to input the desired value, and press the "M" key again to complete the task. The display will then return to the F12 - GCF screen, which indicates the task is completed. Use the "Up" or "Down" key to select F99 - qUIT and the "M" key to exit the MENU and return to the Main Display screen.

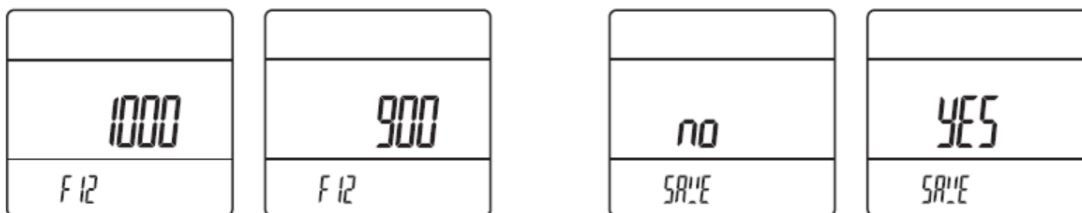

### 5.4.7 Set the 2<sup>nd</sup>-correction factor



Following the above-mentioned steps, at the MENU setting screen, use the "Up" or "Down" key to select F14 - Corr and then press the "M" key to set the 2<sup>nd</sup>-correction factor.

### 5.4.8 Set the Response time

Following the above-mentioned steps, at the MENU setting screen, use the "Up" or "Down" key to select F16 - rESPS and then press the "M" key to set the response time.

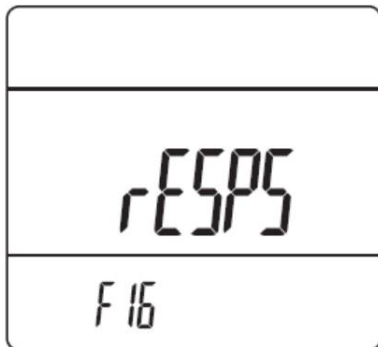

There are 6 response time selectable: 125, 250, 500, 1000, 2000, and 5000, unit is msec. The default response time is 125 msec. Use the "Up" or "Down" key to select the desired one and press the "M" key to confirm. The display will then return to the F16 - rESPS screen, which indicates the task is completed. Use the "Up" or "Down" key to select F99 - qUIT and the "M" key to exit the MENU and return to the Main Display screen.

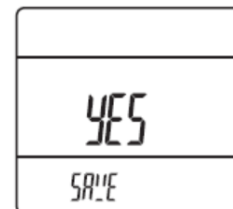
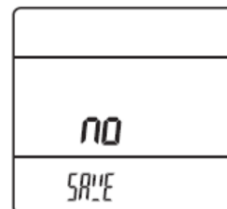
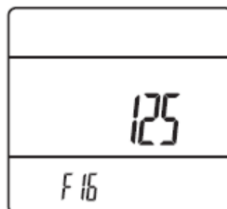

### 5.4.9 Set the unit for the accumulated or totalized flow rate

This function is to set the unit of accumulated flow. If one likes to switch between  $m^3$  and SCF, following the above-mentioned steps, at the MENU setting screen, use the "Up" or "Down" key to select F31 - UnT-A. Press the "M" key to confirm, and it will open the sub-MENU showing the current unit of accumulated flow. Use the "Up" or "Down" and the "M" confirming key to select the desired one, and press the "M" key again to complete the task. The display will then return to the F31 - UnT-A screen, which indicates the task is completed. Use the "Up" or "Down" key to select F99 - qUIT and the "M" key to exit the MENU and return to the Main Display screen.

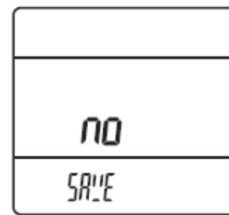
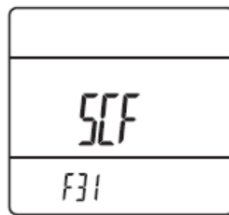
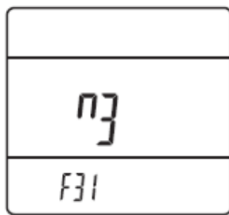
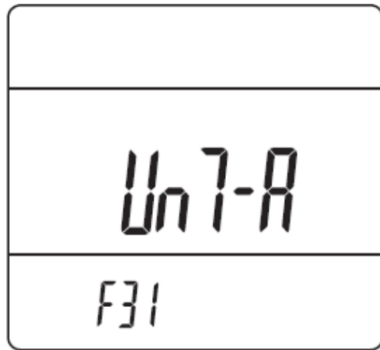

### 5.4.10 Set the unit for the instant flow rate

This function is to set the unit for an instant flow rate. If one likes to switch between SLPM,  $m^3/h$  ( $m^3PH$ ), and SCFM, following the above-mentioned steps, at the MENU setting screen, use the "Up" or "Down" key to select F32 - UnT-F. Press the "M" key to confirm, and it will open the sub-MENU showing the current unit of accumulated flow. Use the "Up" or "Down" and the "M" confirming key to select the desired one, and press the "M" key again to complete the task. The display will then return to the F32 - UnT-F screen, which indicates the task is completed. Use the "Up" or "Down" key to select F99 - qUIT and the "M" key to exit the MENU and return to the Main Display screen.

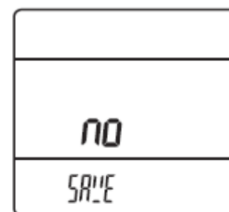
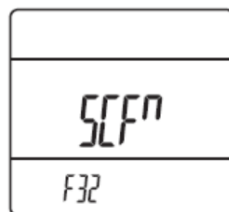
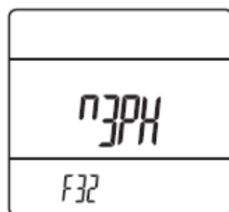
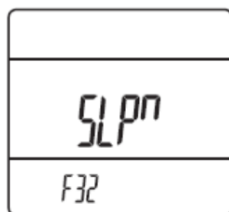
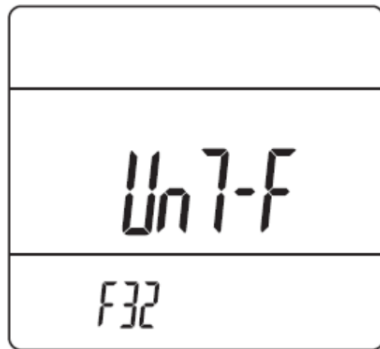

### 5.4.11 Change the default password

For data safety, it is recommended that the default password of 11111 should be changed when the first use of this product.

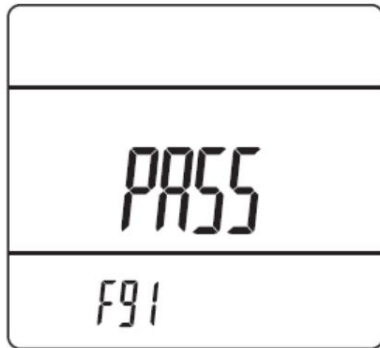

Following the above-mentioned steps, at the MENU setting screen, use the "Up" or "Down" key to select F91 - PASS. Press the "M" key to confirm, and it will open the sub-MENU showing the default password of 11111. Use the "Up" or "Down" and the "M" confirming key to enter the desired one, and press the "M" key again to complete the task. The display will then return to the F91 - PASS screen, which indicates the task is completed. Use the "Up" or "Down" key to select F99 - qUIT and the "M" key to exit the MENU and return to the Main Display screen.

Please keep the changed password in a safe yet accessible place. In case it is unrecoverable, please contact the manufacturer to obtain a special password to access the meter MENU.

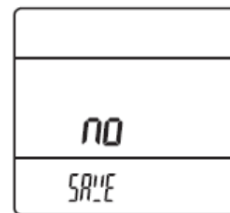

### 5.4.12 Reset the accumulated or totalized flow rate

The maximum value of the accumulated or totalized flow rate that the internal register can have is 9999999. The register will stop accumulating once the value is reached. At this time, it is necessary

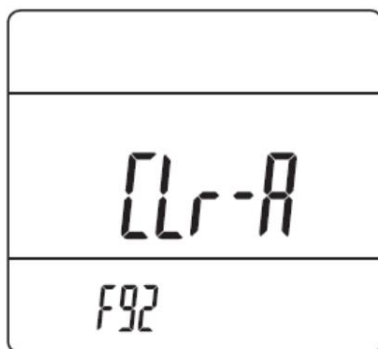

to reset this register. Following the above-mentioned steps, at the MENU setting screen, use the "Up" or "Down" key to select F92 - CLr-A. Press the "M" key to confirm, and it will open the sub-MENU for resetting the value. Use the "Up" or "Down" to select and the "M" confirming key to execute, and press the "M" key again to complete the task. The display will then return to the F92 - CLr-A screen, which indicates the task is completed. Use the "Up" or "Down" key to select F99 - qUIT and the "M" key to exit the MENU and return to the Main Display screen.

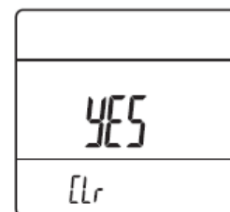
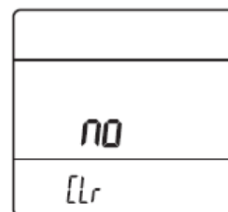

### 5.4.13 Reset the 2<sup>nd</sup>-correction factor

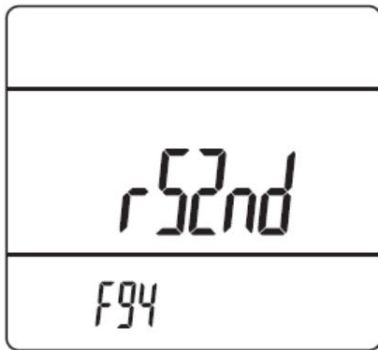

Following the above-mentioned steps, at the MENU setting screen, use the "Up" or "Down" key to select F14 - Corr and then press the "M" key to set the 2<sup>nd</sup>-correction factor.

### 5.4.14 Exit the MENU

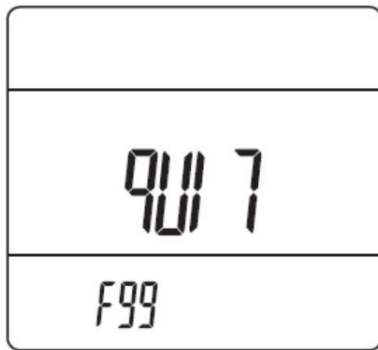

At the MENU settings, use the "Up" or "Down" key to select the F99 - qUIT option and press the "M" confirming key to exit the MENU settings and return to the Main Display screen.

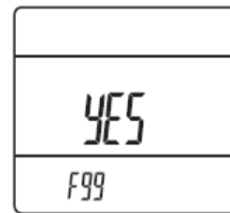
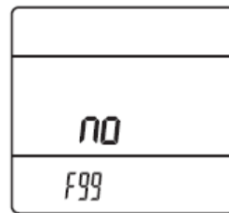

### 5.4.15 MENU key sequence for the settings

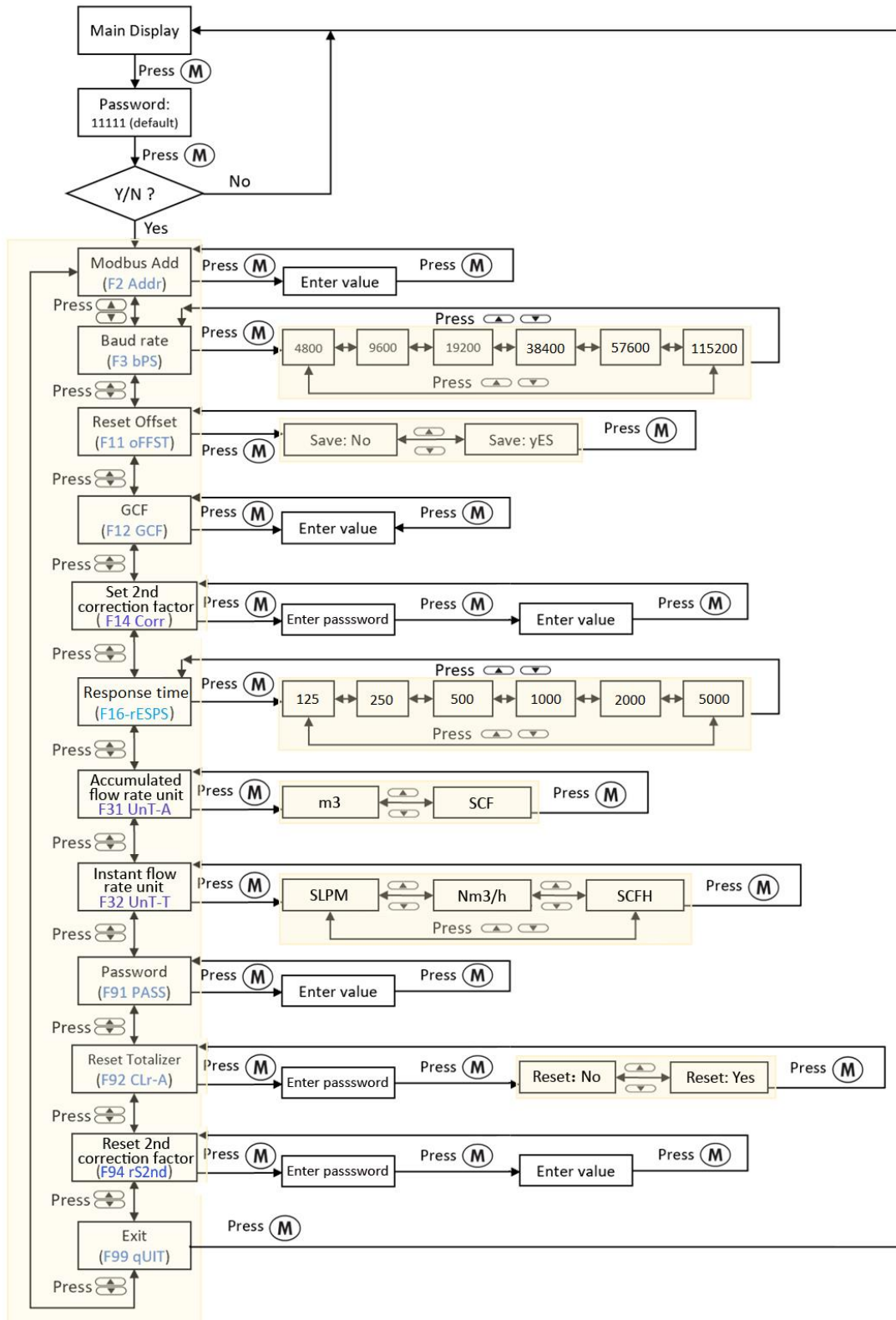

Figure 5.2: MF5000 MENU key sequence

## 5.5 RS485 Modbus communication protocol

The digital communication protocol is based on standard Modbus RTU Half-plex mode. A master (PC or PLC) can communicate with multiple slaves (the current product) for data exchange and communication parameter configuration. Refer to Table 3.2 for cable connection.

### 5.5.1 Hardware connection

The hardware layer is TIA/EIA-485-A, as illustrated below. In this configuration, the product (MF5000) is a slave.

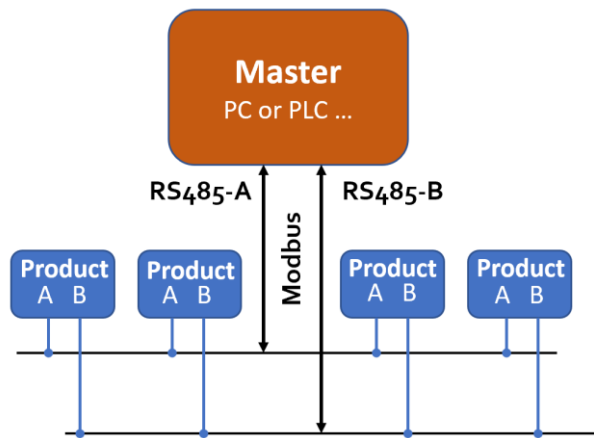

Figure 5.3: RS485 hardware connection

### 5.5.2 Communication parameters

The PC UART communication parameters are listed in the following table.

Parameters	Protocol
	RTU
Baud rate (Bits per second)	9600 bps
Start bits	1
Data bits	8
Stop bits	1
Even/Odd parity	None
Bits period	104.2 $\mu$ sec
Bytes period	1.1458 msec
Maximum data length	20
Maximum nodes	247



### 5.5.3 Frame

The frame function is based on the standard Modbus RTU framing:

Start_bits	Address	Function codes	Data	CRC	Stop_bits
T <sub>1</sub> -T <sub>2</sub> -T <sub>3</sub> -T <sub>4</sub>	8 bit	8 bit	N 8 bit (20≥n≥0)	16 bit	T <sub>1</sub> -T <sub>2</sub> -T <sub>3</sub> -T <sub>4</sub>

**Start\_bits:** 4 periods bit time, for a new frame.

**Address:** The address can be set from 1 to 255 except for 157 (0x9d). 0 is the broadcast address.

**Function codes:** Define the product (MF5900)'s functions/actions (slaves), either execution or response.

**Data:** The address of the register, length of data, and the data themselves.

**CRC:** CRC verification code. The low byte is followed by the high byte. For example, a 16-bit CRC is divided into BYTE\_H and BYTE\_L. In the framing, the BYTE\_L will come first, then followed by the BYTE\_H. The last one is the STOP signal.

**Stop\_bits:** 4 periods bit time, for ending the current frame.

### 5.5.4 Function codes

The Modbus function codes applied for the product are the sub-class of the standard Modbus function codes. These codes are used to set or read the registers of the product:

Code	Name	Functions
0x03	Read register	Read register(s)
0x06	Set single register	Write one single 16-bit register
0x10	Set multiple registers	Write multiple registers

### 5.5.5 Registers

The product (MF5000) has multiple registers available for the assignment of the various functions. With these functions, the user can obtain the data from the products, such as *product address* and *flow rates* from the registers, or set the product functions by writing the corresponding parameters.

The currently available registers are listed in the following table, and the registers may be customized upon contacting the manufacturer. Where R: read; W: write-only; W/R: read and write.

**Note:** At the time of shipping, the write protection function is enabled except for address and baud rate. Once the user completes the register value change, the write protection will be automatically enabled once again to prevent incidental data loss.

Functions	Description	Register	Modbus reference
Address	Product address (R/W)	0x0081	40130 (0x0081)
Serial number	Serial number of the product	0x0030~0x0035	40049 (0x0030)
Flow rate	Current flow rate (R)	0x003A~0x003B	40059 (0x003A)
Accumulated flow	Accumulated or totalized flow rate (R)	0x003C~0x003E	40061 (0x003C)
Baud rate	Communication (R/W)	0x0082	40131 (0x0082)
GCF*	Gas correction factor (R/W)	0x008B	40140 (0x008B)
Response time*	Set the response time (R/W)	0x008D	40142 (0x008D)
Units*	Instant and accumulated flow rate units (R/W)	0x0090	40145 (0x0090)
Password*	Password change (R/W)	0x00AE~0x00AF	40175 (0x00AE)
Reset offset*	Reset or calibrate the offset (W)	0x00F0	40241 (0x00F0)
Reset totalizer*	Reset accumulated or totalized flow rate (W)	0x00F2	40243 (0x00F2)
Write protection	Write protection of selected parameters (W)	0x00FF	40256 (0x00FF)

**Notes:** 1, R – Read-only, W – Write only, R/W – Read and write.

2, For the \* marked functions, need to disable the write protection before setting.

The detailed information of each register is described below: Y: enabled; N: disabled

Address	0x0081	Write	Y
		Read	Y
Description	RS485 Modbus address of the flow meter		
Value type	UINT 16		
Notes	Values from 1 to 255 except for 157 (0x9d). Broadcast address 0 is not enabled, the default address is 1.		

SN, Serial number	0x0030	Write	N
		Read	Y
Description	Series Number of the product, SN		
Value type	UINT8 (12 bits)		
Notes	SN= value(0x0007), value(0x0008),...,value (0x000C); e.g.: Receiving 12 bits as: 0x2A47, 0x3741, 0x4549, 0x3032, 0x3035, 0x382A , the corresponding Serial Number is *G7AE102058*.		

Instant flow rate	0x003A ~ 0x003B	Write	N
		Read	Y
Description	Instant flow rate		
Value type	UINT 16		
Notes	Flow rate = [Value (0x003A)*65536 + value (0x003B)]/1000 e.g.: For a flow rate of 20.340 L/min, the user will read "0 (0x0000)" from register 0x003A and "20340 (0x4F74)" from register 0x003B, therefore Current flow rate = (0*65536+20340)/1000 = 20.340		

<b>Accumulated flow rate</b>	<b>0x003C ~ 0x003E</b>	<b>Write</b>	N
		<b>Read</b>	Y
<b>Description</b>	Accumulated or totalized flow rate		
<b>Value type</b>	UINT 32 + UNIT 16		
<b>Notes</b>	Accumulated flow rate $= \text{Value (0x003C)} * 65536 + \text{Value (0x003D)} + \text{Value (0x003E)}/1000$ <b>e.g.:</b> For an accumulated flow rate of 3452.245 m <sup>3</sup> , the user will read "0 (0x0000)" from register 0x003C; "3452 (0x0D7C)" from register 0x003D, and "245 (0x00F5)" from register 0x003E. Then, the accumulated flow rate = 0 + 3425 + 245/1000=3425.245.		

<b>Baud rate</b>	<b>0x0082</b>	<b>Write</b>	Y
		<b>Read</b>	Y
<b>Description</b>	Communication baud rate with a PC		
<b>Value type</b>	UINT 16		
<b>Notes</b>	0 - 4800; 1 - 9600; 2 - 19200; 3 - 38400; 4 - 57600; 5 - 115200. The default value is 1, the baud rate is 9600. <b>e.g.:</b> When the user reads "2 (0x0002)" from register 0x0082, the baud rate is 19200.		

<b>GCF</b>	<b>0x008B</b>	<b>Write</b>	Y
		<b>Read</b>	Y
<b>Description</b>	The gas conversion factor for a gas that is different from the calibration gas.		
<b>Value type</b>	UINT 16		
<b>Notes</b>	The air (default) is 1000, normally read from register 0x008B. <b>The product will disable this function with write protection once the metering gas is confirmed with the proper GCF.</b> For a specific GCF value, please contact the manufacturer. <b>Notes: please disable the write protection before executing this function.</b>		

<b>Response time</b>	<b>0x008D</b>	<b>Write</b>	Y
		<b>Read</b>	Y
<b>Description</b>	Set response time		
<b>Value type</b>	UINT 16		
<b>Notes</b>	125, 250, 500, 1000, 2000, or 5000, unit is msec. The default value is 125 msec. <b>e.g.:</b> When the user reads "2000" from register 0x008D, the response time is 2000 msec (2 sec). <b>Notes: please disable the write protection before executing this function.</b>		

<b>Units</b>	<b>0x0090</b>	<b>Write</b>	Y
		<b>Read</b>	Y
<b>Description</b>	Set the instant flow rate unit, and accumulated or totalized flow rate unit		
<b>Value type</b>	UINT 16		

<b>Notes</b>	<p>5 - instant flow rate unit m<sup>3</sup>/h, accumulated or totalized flow rate unit m<sup>3</sup>;        8 - instant flow rate unit SLPM, accumulated or totalized flow rate unit m<sup>3</sup>;        9 - instant flow rate unit SCFM, accumulated or totalized flow rate unit SCF.        The default value is 8.  <b>e.g.:</b> When the user reads "8" from register 0x0090, the instant flow rate unit is SLPM, accumulated or totalized flow rate unit is m<sup>3</sup>.  <b>Notes: please disable the write protection before executing this function.</b></p>		
--------------	---	--	--

<b>Change password</b>	<b>0x00AE ~ 0x00AF</b>	<b>Write</b>	Y
		<b>Read</b>	Y
<b>Description</b>	Change the default password		
<b>Value type</b>	UINT 32		
<b>Notes</b>	Password values = Value (0x00AE)*65536 + Value (0x00AF) Available: 00000 ~ 99999 <b>Notes: please disable the write protection before executing this function.</b>		

<b>Offset calibration</b>	<b>0x00Fo</b>	<b>Write</b>	Y
		<b>Read</b>	N
<b>Description</b>	Reset or calibrate the offset		
<b>Value type</b>	UINT 16, Fixed value 0xAA55		
<b>Notes</b>	To reset or calibrate the offset, write 0xAA55 to register 0x00Fo. <b>When you execute this function, make sure there is NO flow in the flow channel.</b> <b>Notes: please disable the write protection before executing this function.</b>		

<b>Reset accumulated flow rate</b>	<b>0x00F2</b>	<b>Write</b>	Y
		<b>Read</b>	N
<b>Description</b>	Reset the accumulated or totalized flow rate value		
<b>Value type</b>	UINT 16, Fixed value 0x0001		
<b>Notes</b>	To reset the accumulated or totalized flow rate value, write 0x0001 to register 0x00F2. <b>Notes: please disable the write protection before executing this function.</b>		

<b>Write protection</b>	<b>0x00FF</b>	<b>Write</b>	Y
		<b>Read</b>	N
<b>Description</b>	Write protection disabler for a set value to a specific register.		
<b>Value type</b>	UINT 16, Fixed value 0xAA55		
<b>Notes</b>	This function is enabled at the time of product shipment. To enable the write function of a specific parameter, such as GCF, the user needs to send 0xAA55 to the register 0x00FF, and then the write function will be enabled (write protection is disabled). After the write execution is completed, the firmware will automatically re-enable the write protection.		

### 5.6 Analog (4 ~ 20 mA) output

The loop resistor connection is illustrated below. The current output load depends on the power supply (the yellow area in the graph). The maximum load resistor,  $R_L$ , with a 24Vdc supply, will be 850 Ohm.

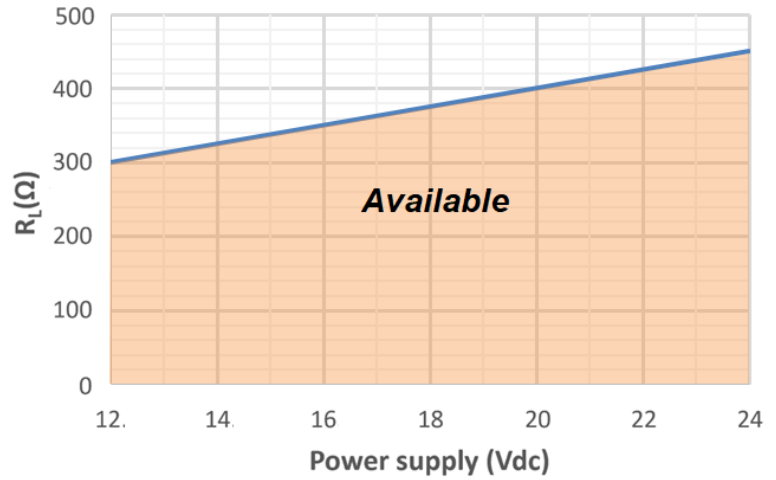
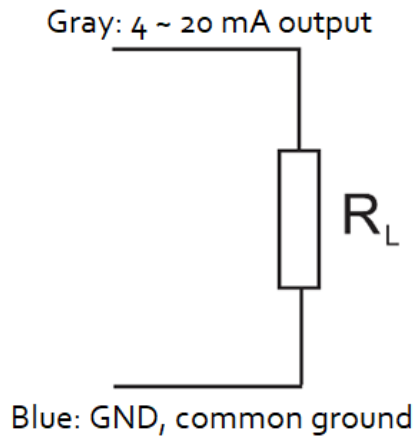

Figure 5.4: Analog output.

## 6. Product selection

The product part number is composed of the product model number and suffixes indicating the full-scale flow rate, as well as the other parameters. Refer to the following for details.

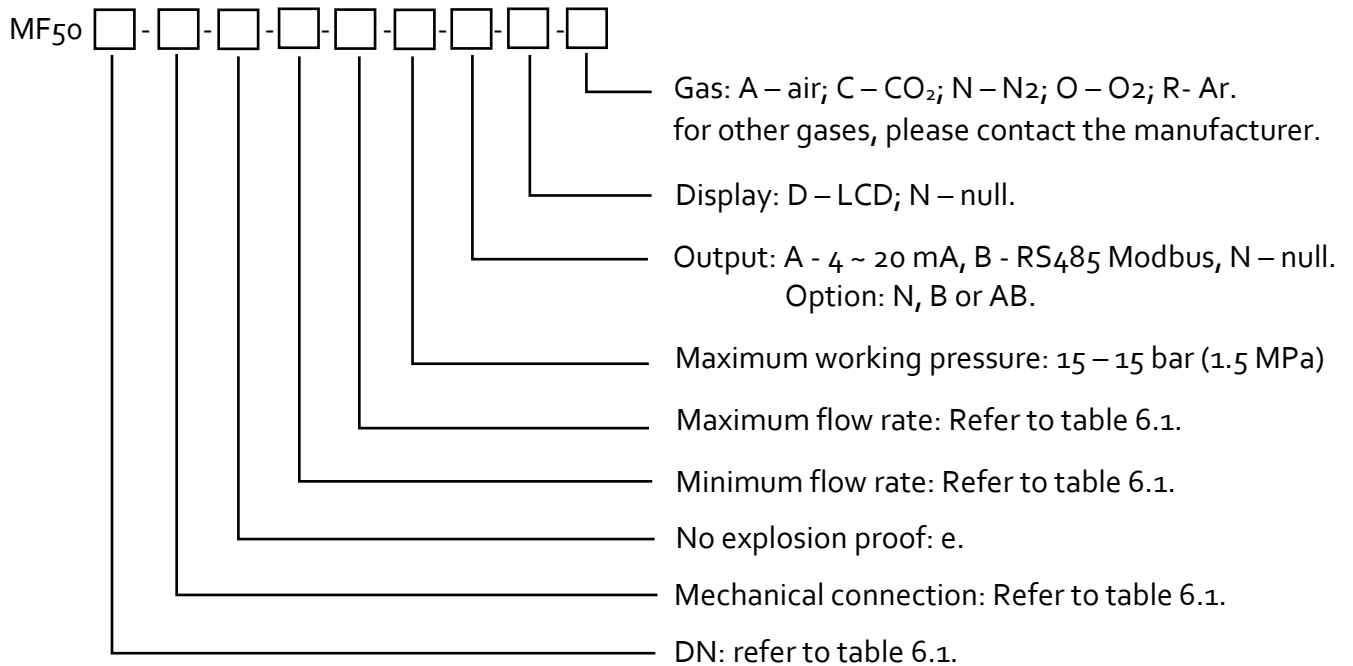

Table 6.1: Mechanical connection and flow range of all models.

Model	DN (mm)	Mechanical connection	Flow range		
			SLPM	m <sup>3</sup> /h	SCFM
MF5003	3.0	N1M: NPT 1/8 male N1F: NPT 1/8 female	0.15 ~ 15		-
MF5006	6.0	N2M: NPT 1/4 male N2F: NPT 1/4 female	0.5 ~ 50	0.03 ~ 3	0.02 ~ 2
MF5008	8.0	N3M: NPT 3/8 male N3F: NPT 3/8 female	1.2 ~ 120	0.072 ~ 7.2	0.05 ~ 5
MF5012	12.0	N4M: NPT 1/2 male N4F: NPT 1/2 female	3 ~ 300	0.18 ~ 18	0.1 ~ 10
MF5019	19.0	N6M: NPT 3/4 male N6F: NPT 3/4 female	8 ~ 800	0.48 ~ 48	0.3 ~ 30

e.g. MF5006-N2F-E-0.5-5-15-AB-D-A

## 7. Technical specifications

### 7.1 Specifications

All specifications listed in the following table unless otherwise noted apply for calibration conditions at 20°C and 101.325 kPa absolute pressure with air. The product is horizontally mounted at the time of calibration.

	Value	Unit
Full-scale flow range	See table 6.1	SLPM
Accuracy	$\pm(1.5+0.20FS)$	%
Repeatability	0.5	%
Turn-down ratio	100:1	
Working temperature	-20 ~ 60	°C
Maximum pressure	1.5	MPa
Humidity	<95, no condensation	%RH
Power supply	12 ~ 24 (50 mA)	Vdc
Output*	RS485 Modbus half-duplex / 4 ~ 20	
MENU access	mA 3 key – front face keyboard/digital	
Display	Instant flow rate, Accumulated or totalized flow rate	
Mechanical connection	NPT or customized	
Protection	IP66	
Storage temperature	-20 ~ 70	°C
Reference conditions	20°C, 101.325 kPa, air	
Fluid compatibility	Non-corrosive	
CE	EN61326-1; -2; -3	

	MF5003	MF5006	MF5008	MF5012	MF5019	
Maximum overflow	30	120	200	450	1200	SLPM
Maximum flow change	4	15	30	60	150	SLPM/sec

**Note:** For other features or specifications not listed, please contact the manufacturer.

## 7.2 Pressure loss

### 7.2.1 MF5003

Flow rate (SLPM)	Pressure loss (Pa/PSI)
2.0	80 / 0.012
4.0	290 / 0.042
6.0	630 / 0.091
8.0	1100 / 0.159
10.0	1690 / 0.245
12.0	2420 / 0.351
15.0	3750 / 0.544

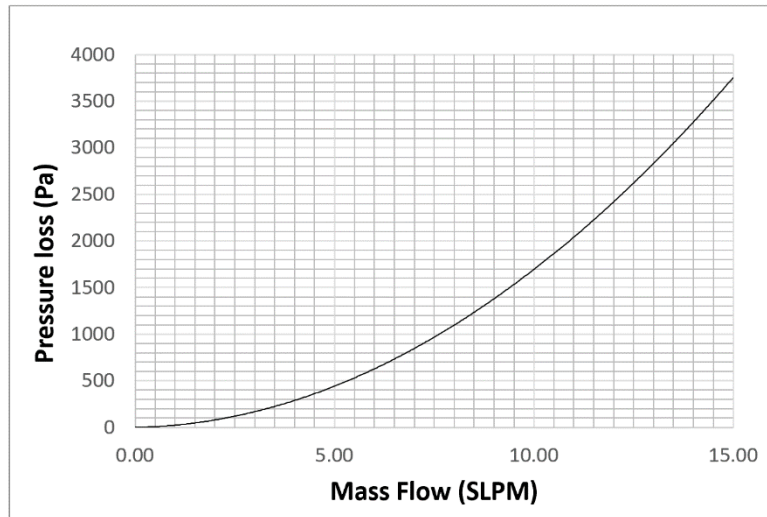

### 7.2.2 MF5006

Flow rate (SLPM)	Pressure loss (Pa/PSI)
2.0	5 / 0.001
5.0	21 / 0.003
10.0	70 / 0.010
20.0	250 / 0.036
30.0	540 / 0.079
40.0	950 / 0.138
50.0	1460 / 0.213

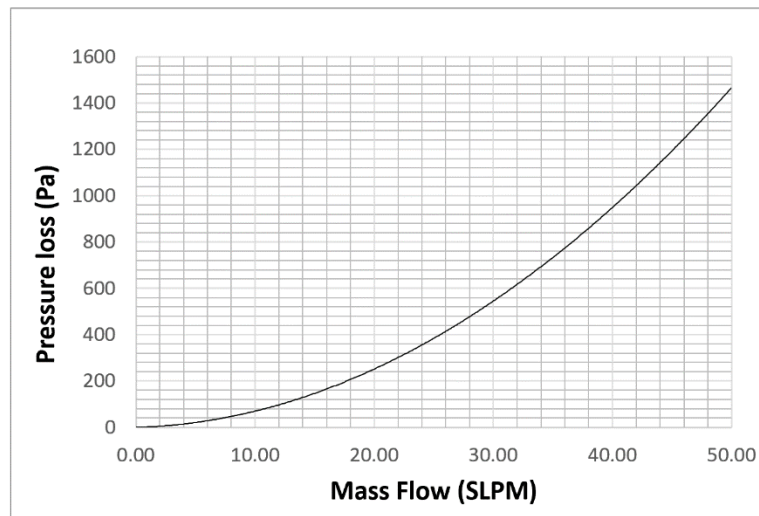



### 7.2.3 MF5008

Flow rate (SLPM)	Pressure loss (Pa/PSI)
5.0	30 / 0.004
10.0	65 / 0.009
20.0	150 / 0.022
40.0	415 / 0.060
60.0	790 / 0.114
80.0	1270 / 0.184
100.0	1860 / 0.270
120.0	2560 / 0.371

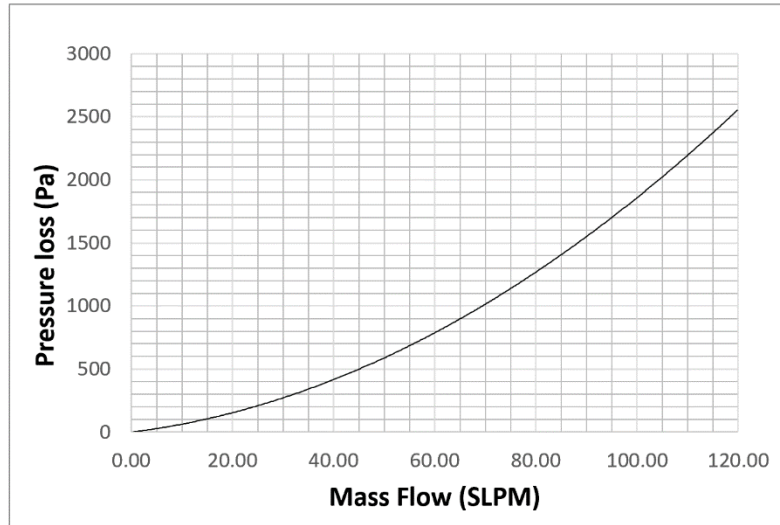

### 7.2.4 MF5012

Flow rate (SLPM)	Pressure loss (Pa/PSI)
30.0	110 / 0.016
50.0	215 / 0.031
70.0	350 / 0.051
100.0	610 / 0.088
150.0	1185 / 0.173
200.0	1950 / 0.282
250.0	2885 / 0.418
300.0	4000 / 0.581

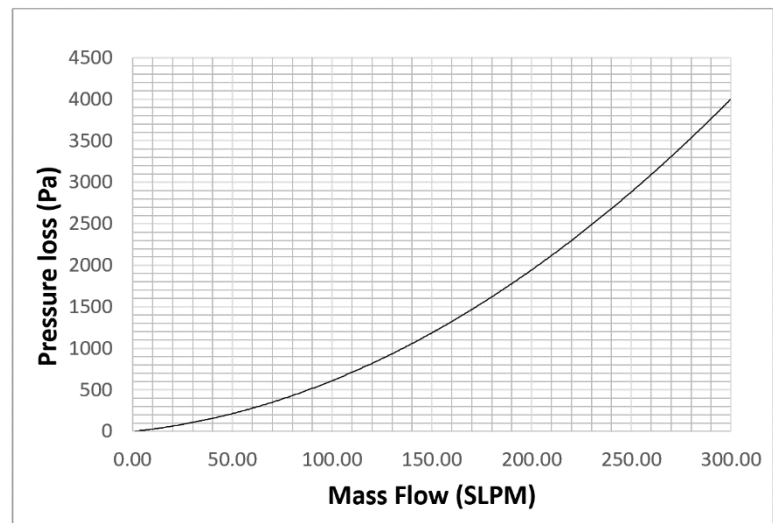

### 7.2.5 MF5019

Flow rate (SLPM)	Pressure loss (Pa/PSI)
50.0	60 / 0.008
100.0	140 / 0.020
200.0	370 / 0.053
300.0	695 / 0.100
400.0	1110 / 0.161
500.0	1625 / 0.236
600.0	2230 / 0.324
700.0	2930 / 0.425
800.0	3730 / 0.541

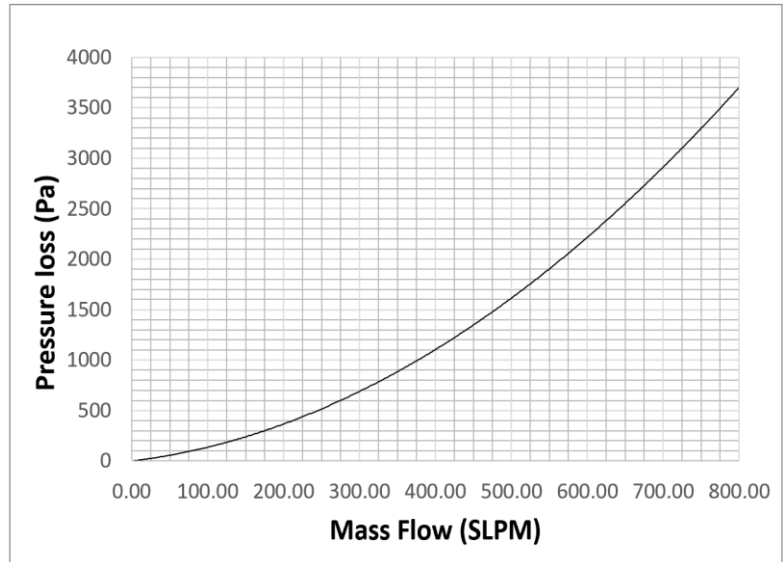

## 8. Technical notes for the product performance

### 8.1 Measurement principle

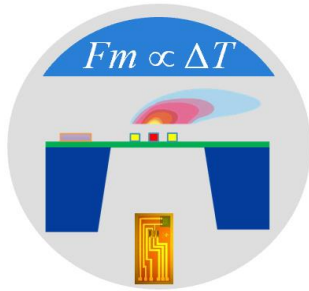

Figure 8.1: Measurement approach illustration.

The products utilize the Company's proprietary micro-machined (MEMS) calorimetric sensing and data process technology. A thermal signal generator with a pair of sensing elements at up and downstream of the microheater is precisely manufactured and separated at predefined micrometer distances on a chip surface with excellent thermal isolation. When a fluid is flowing through the sensing chip, the fluid carries the thermal signal downstream. The sensing elements register the temperature differences, further correlated to the fluid mass flow rate via the calibration process.

The calorimetric sensing approach offers a large dynamic range with a better performance against the environmental parameter alternations.

Please refer to the company's US patents and other publications made available to the public for additional information.

### 8.2 Precautions for the best performance of the product

#### 8.2.1 Comparison with a third-party reference meter

It is very common that a user may compare the data from the product with a third-party reference meter, and in many cases, there could be some discrepancies.

When performing such a comparison, please note that the reference meter should have a better-specified accuracy (about 1/3 of the product), and pay special attention to the differences in the reading accuracy and full-scale accuracy.

A full scale accuracy = reading accuracy x (full scale flow rate/ set point (current) flow rate)

Another key point to comparing the different flow meters is that as long as the fluidic flow is a continuous flow without pulsation, then the fluidic dynamic will have the system following the Bernoulli equation:

$$P_1 + \frac{1}{2}\rho v_1^2 + \rho g h_1 = P_2 + \frac{1}{2}\rho v_2^2 + \rho g h_2$$

where  $\rho$  is the fluid density;  $g$  is the acceleration due to gravity;  $P_1$  is the pressure of the reference meter;  $P_2$  is the pressure at the test meter;  $v_1$  is the velocity of the reference meter, and  $v_2$  is the velocity of the test meter.  $h_1$  and  $h_2$  are the corresponding height for the meters which in most cases is the same in the system. Therefore, it would be very critical to have the system not have a pressure variation. (This explains our recommendations for the installations in Section 4). Also, the meter measurement principle is often very important for the understanding of any discrepancies.

### **8.2.2 Particle contamination and fluidic cleanness**

Any contamination including particles and liquid vapors would be detrimental to the accuracy of the flow measurement and also to the meter functionality. It is important to ensure the applied flow medium will be clean and dry. If any contamination is suspected, please allow experienced technical personnel to have it checked and re-conditioned. Do not use a foreign cleanser or other fluids to clean the flow path which could bring irrecoverable damage.

### **8.2.3 Apply to a different gas medium**

The product is calibrated with a high precision NIST traceable metrological standard with clean and dry air. In case the meter will be applied to meter the other clean and dry gas, a correct gas conversion factor needs to be registered into the meter before the measurement.

The meter operates similarly to the principle described in the international standard for thermal mass flow meters (ISO 14511:2001 - Measurement of fluid flow in closed conduits — Thermal mass flowmeters). Due to the meter assembled procedure, the head loss value from the meter to the meter would not be 100% identical, and at the large dynamic measurement range, the thermal response would also have some deviations and nonlinearity from gas to gas. Therefore, measurement by the meter for a gas medium other than the calibration gas would bear larger measurement errors, particularly at the low Reynold number range where the laminar flow has a sensitive flow profile.

## 9. Troubleshooting

Phenomena	Possible causes	Actions
No signal / display	Power not connected; battery empty	Connect the power, check the cable
	Cable connection incorrect	Check cable
	No flow or clogging	Check flow and contamination
	Power regulator failure	Return to factory
	Sensor failure	Return to factory
Large errors or unexpected flow rate	Particles, fluid type	Check system
Erroneous or large noise	Vibration, unstable flow	Check system
Valve not work	Wire connection, valve	Return to factory
Offset unstable	Circuitry instability	Check system, power off
No digital interface	Wrong address, software	Check commands, connection
No wireless, BT cannot pair	Wrong model, data jam	Check model, power off/on

## 10. Warranty and Liability

(Effective January 2018)

Siargo warrants the products sold hereunder, properly used, and properly installed under normal circumstances and service. As described in this user manual, it shall be free from faulty materials or workmanship for 180 days for OEM products and 365 days for non-OEM products from the date of shipment. This warranty period is inclusive of any statutory warranty. Any repair or replacement serviced product shall bear the same terms in this warranty.

Siargo makes no warranty, representation, or guarantee and shall not assume any liability regarding the suitability of the products described in this manual for any purposes that are not specified in this manual. The users shall be held full responsibility for validating the performance and suitability of the products for their particular design and applications. For any misuse of the products out of the scope described herein, the user shall indemnify and hold Siargo and its officers, employees, subsidiaries, affiliates, and sales channels harmless against all claims, costs, damages, and expenses or reasonable attorney fees from direct or indirect sources.

Siargo makes no other warranty, express or implied, and assumes no liability for any special or incidental damage or charges, including but not limited to any damages or charges due to installation, dismantling, reinstallation, etc. other consequential or indirect damages of any kind. To the extent permitted by law, the exclusive remedy of the user or purchaser, and the limit of Siargo's liability for any and all losses, injuries, or damages concerning the products, including claims based on contract, negligence, tort, strict liability, or otherwise shall be the return of products to Siargo, and upon verification of Siargo to prove to be defective, at its sole option, to refund, repair or replacement of the products. Regardless of form, no action may be brought against Siargo more than 365 days after a cause of action has accrued. The products returned under warranty to Siargo shall be at the user or purchaser's risk of loss and will be returned, if at all, at Siargo's risk of loss. Purchasers or users are deemed to have accepted this limitation of warranty and liability, which contains the complete and exclusive limited warranty of Siargo. It shall not be amended, modified, or its terms waived except by Siargo's sole action.

This manual's product information is believed to be accurate and reliable at the time of release or made available to the users. However, Siargo shall assume no responsibility for any inaccuracies and/or errors and reserves the right to make changes without further notice for the relevant information herein.

This warranty is subject to the following exclusions:

- (1) Products that have been altered, modified, or have been subject to unusual physical or electrical circumstances indicated but not limited to those stated in this document or any other actions which cannot be deemed as proper use of the products;

- (2) Products that have been subject to chemical attacks, including exposure to corrosive substances or contaminants. In the case of battery usage, long-term discharge or leakage induced damages;
- (3) Products that have been opened or dismantled for whatever reasons;
- (4) Products that have been subject to working conditions beyond the technical specification as described by this manual or related datasheet published by the manufacturer;
- (5) Any damages incurred by the incorrect usage of the products;
- (6) Siargo does not provide any warranty on finished goods manufactured by others. Only the original manufacturer's warranty applies;
- (7) Products that are re-sold by unauthorized dealers or any third parties.

## 11. Service/order contact and other information

Siargo Ltd. is making every effort to ensure the quality of the products. In case of questions and or product support, please contact your direct sales, or in case you need additional assistance, please contact customer service at the address listed below. We will respond to your request in a timely fashion and work with you toward your complete satisfaction.

For sales or product orders, please contact the local sales representatives or distributors that can be found on the company's webpage: [www.Siargo.com](http://www.Siargo.com).

For any returns, please contact your direct sales to obtain an RMA. In case you need any further assistance, please contact [info@siargo.com](mailto:info@siargo.com) to obtain additional information or a Return Materials Authorization (RMA) before shipping the product back to the factory for factory services such as calibration. Please specify as clearly as possible in your email message about the product's status that you intend to ship back to the factory, and include your shipping address. Be sure to write the RMA on the returned package or include a letter with the RMA information.

Direct customer service request(s) should be addressed to

Siargo Ltd.  
3100 De La Cruz Boulevard, Suite 210,  
Santa Clara, California 95054, USA  
Phone: +01(408)969-0368  
Email: [info@Siargo.com](mailto:info@Siargo.com)

For further information and updates, please visit [www.Siargo.com](http://www.Siargo.com).



## Appendix I: Product evaluation kit

Siargo offers a product evaluation kit, including a digital data converter, USB data cable, and User Application software, that allows the user to evaluate the product performance on a Microsoft Windows-based computer. For some simple applications with digital data transfer, this kit could serve the purpose. The user can read and visualize the flow rate of the product, obtain the accumulated or totalized flow rate values, and save the data for further analysis. It can read from up to 128 sensors with the RS485 interface in serial.

For further information and purchase of the evaluation kit, please contact the manufacturer or the sales representative.

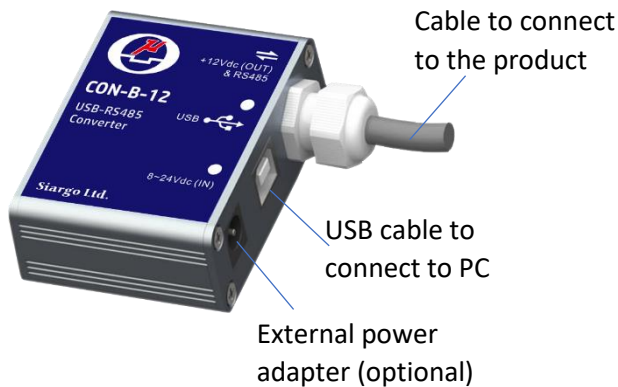

Each converter has a fixed cable that can be directly connected to the product. The USB cable connected to the PC is also included.

For most of the products, the power from the PC via the USB cable will be sufficient to power the sensor product, no external power will be required. However, for multiple sensors in serial, the power via the USB cable may not be enough, an external power adapter with 8 ~ 24Vdc will be required.

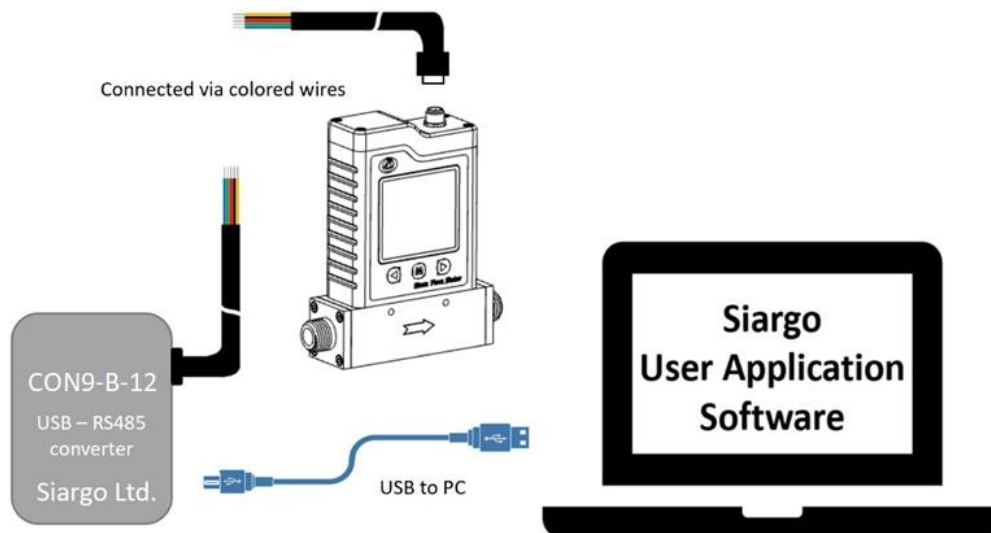

## Appendix II: Document history

### Revision E.2.01 (July 2022):

- Update service and contact information.

### Revision E.2 (April 2022):

- Update MENU description.

### Revision E.1 (April 2022):

- Add the pressure loss data.

### Revision E.0 (February 2022):

- Major upgrade, the 3rd generation, for additional information, please see the overview.

### Revision D.2 (April 2021):

- Corrections.

### Revision D.1 (March 2021):

- Reformat, corrections, and add the evaluation kit.

### Revision C.7 (July 2019):

- Update the MENU key functions.

### Revision C.6 (July 2018):

- Add the RS485 Modbus protocol (Mode P1).

### Revision C.5 (November 2017):

- Add the maximum overflow and maximum flow changes;
- Add the revision history (Appendix).

.....

### Revision A.0 (October 2007):

- First release



**SMERI s.r.l.**

I 20057 Assago (MI) - Via Mario Idiomi 3/13

Tel: +39 02 5398941

E-mail: smeri@smeri.com - www.smeri.com

