

Serie **VN 1000**
 VN 2000
 VN 5000
 VN 6000

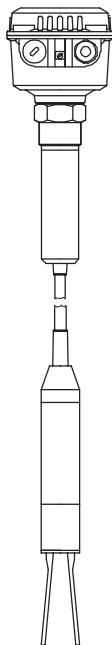
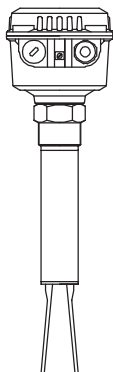
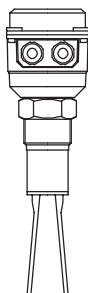

Istruzioni d'uso

UWT GmbH

Westendstraße 5
D-87488 Betzigau

Tel.: +49 (0)831 57123-0

Fax: +49 (0)831 76879

Internet: www.uwtgroup.com

E-Mail: info@uwtgroup.com

Queste istruzioni d'uso sono valide per:	Tipi	VN 1020 1030 1050 VN 2020 2030 2050 VN 5020 5030 5050 VN 6020 6030 6050
	Omologazione	CE / TR-CU ATEX 1D 1/2D IEC-Ex t IIIC
	Moduli elettronici	Relè (SPDT, DPDT) PNP 2 fili senza contatto

Indice

Avvertenze di sicurezza/pericoli	Pagina	4
Utilizzo	Pagina	4
Dati tecnici	Pagina	5
Impiego	Pagina	14
Montaggio	Pagina	17
Parti di ricambio	Pagina	21
Conessioni elettriche	Pagina	24
Logica di commutazione	Pagina	28
Manutenzione	Pagina	30
Assemblaggio VN *020, scocca a gradini	Pagina	31
ATEX / IEC-Ex Note	Pagina	32

Avvertenze di sicurezza/pericoli

Installazione, manutenzione e messa in funzione devono essere eseguite esclusivamente da apposito personale specializzato.

Per effettuare l'allacciamento elettrico devono venire rispettate le prescrizioni locali o la norma VDE 0100.

Tutti i cavi di connessione devono essere isolati per una tensione d'esercizio di almeno 250 V CA. Resistenza alle alte temperature: min. 90°C (194°F).

La sicurezza non è garantita in caso di uso improprio dell'apparecchio.

Utilizzo

Interruttore limitatore per la misurazione del livello in materiali sfusi in polvere o granulati.

Dati tecnici

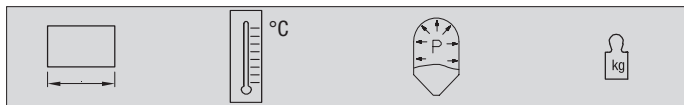

VN 1020
VN 2020

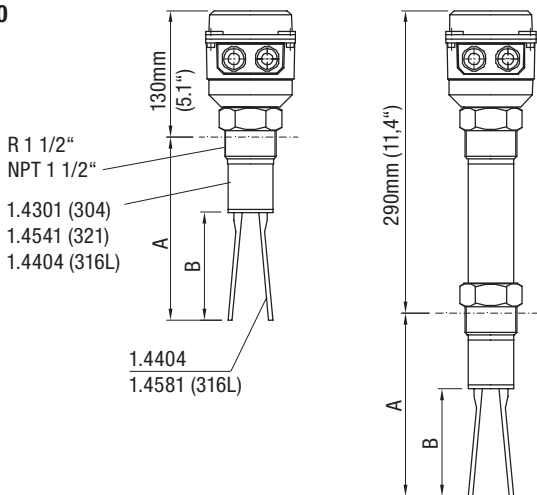

A, B →



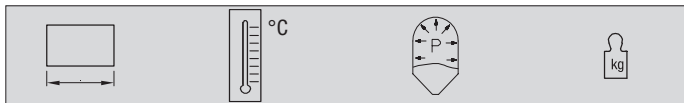

	① →	② →
	-1 .. +16bar (-14.5 .. +232psi)	-1 .. +16bar (-14.5 .. +232psi)
	~ 1,6kg (3.5 lbs)	~ 2,3kg (5 lbs)

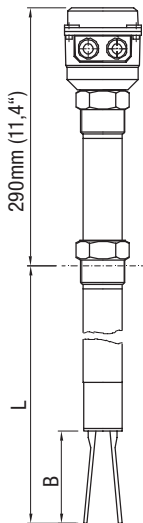
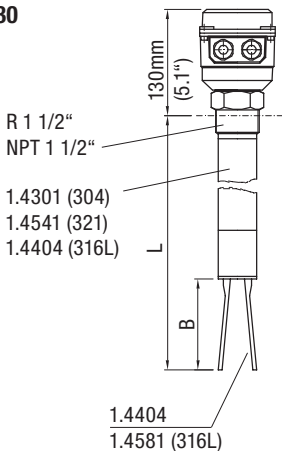

VN 1030
VN 2030



B, L →  11





 °C	① / ② →  12	② →  12
	-1 .. +16bar (-14.5 .. +232psi)	-1 .. +16bar (-14.5 .. +232psi)
 kg	~ 1,6kg (3.5 lbs) +2,5kg/m (+5.5 lbs per 39.9") (L)	~ 2,3kg (5 lbs) +2,5kg/m (+5.5 lbs per 39.9") (L)

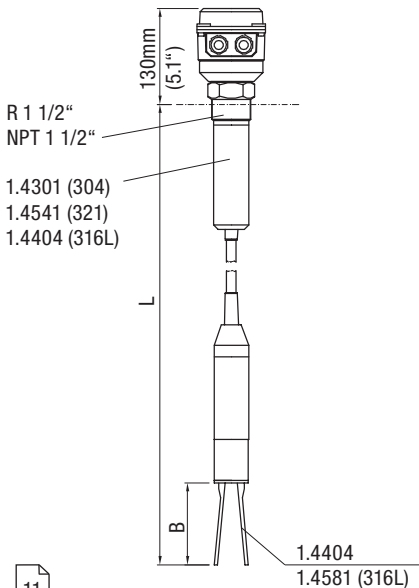

VN 1050
VN 2050



B, L → 



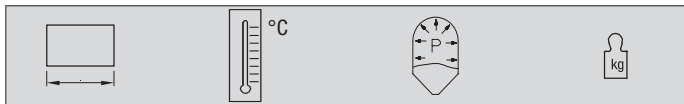

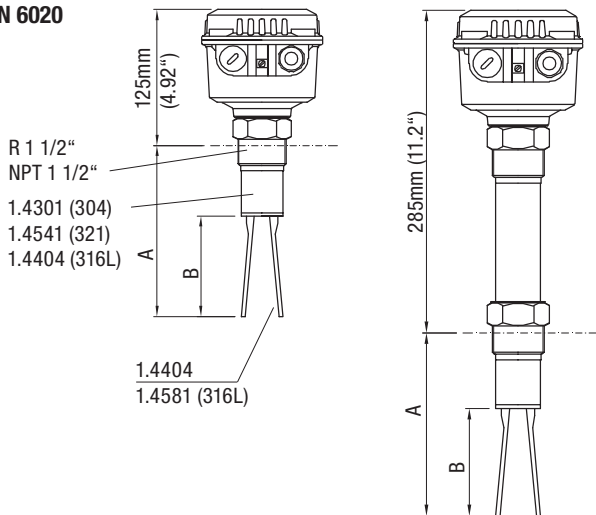

 °C	 → 
	-1 .. +6bar (-14.5 .. +87psi)
 kg	~ 4,0 kg (8.8 lbs) + 0,5 kg/m (+1.1 lbs per 39.9") (L)



VN 5020
VN 6020



A, B → 

	 → 	 → 
	-1 .. +16bar (-14.5 .. +232psi)	-1 .. +16bar (-14.5 .. +232psi)
	~ 2,1kg (4.6 lbs)	~ 2,8kg (6.2 lbs)



VN 5030

VN 6030

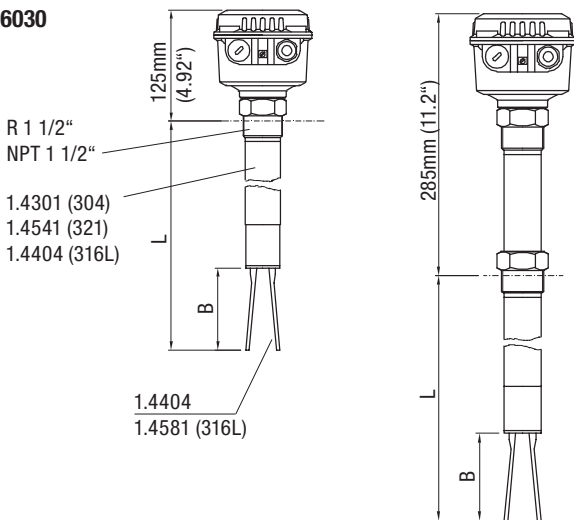

B, L →



	① / ② →	② →
	-1 .. +16bar (-14.5 .. +232psi)	-1 .. +16bar (-14.5 .. +232psi)
	~2,1kg (4.6lbs) +2,5kg/m (+5.5 lbs per 39.9") (L)	~2,8kg (6.2lbs) +2,5kg/m (+5.5 lbs per 39.9") (L)

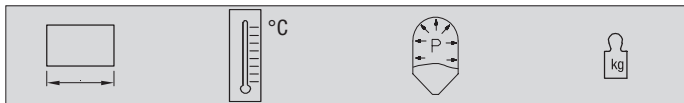

VN 5050
VN 6050

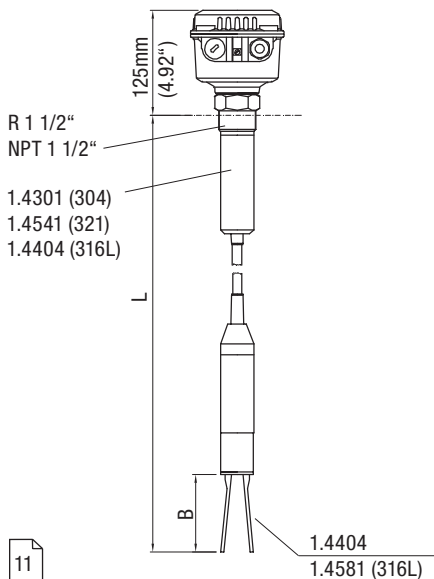

B, L →



	③ →
	-1 .. +6bar (-14.5 .. +87psi)
	~ 4,5 kg (9.9 lbs) + 0,5 kg/m (+1.1 lbs per 39.9") (L)

	A	B	L
VN 1020	165mm (6.5")	100mm (3.94")	
VN 1030		100mm (3.94")	max. 4.000mm (157.5")
VN 1050		100mm (3.94")	max. 7.000mm (276")

VN 2020	235mm (9.25") (1) 260mm (10.2")	170mm (6.69") (1) 195mm (7.68")	
VN 2030		170mm (6.69") (1) 195mm (7.68")	max. 4.000mm (157.5")
VN 2050		170mm (6.69") (1) 195mm (7.68")	max. 20.000mm (787")

VN 5020	165mm (6.5")	100mm (3.94")	
VN 5030		100mm (3.94")	max. 4.000mm (157.5")
VN 5050		100mm (3.94")	max. 7.000mm (276")

VN 6020	235mm (9.25") (1) 260mm (10.2")	170mm (6.69") (1) 195mm (7.68")	
VN 6030		170mm (6.69") (1) 195mm (7.68")	max. 4.000mm (157.5")
VN 6050		170mm (6.69") (1) 195mm (7.68")	max. 20.000mm (787")

(1) Opzione: sensibilità d'intervento > 5 g/l (0.3 lb/ft³)



1

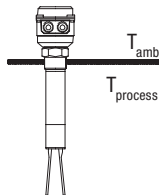
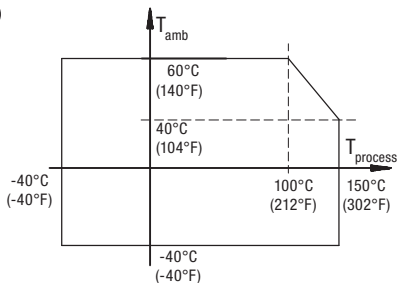

2

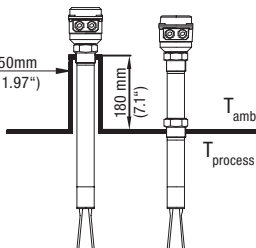
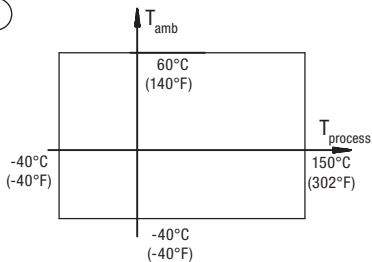

3

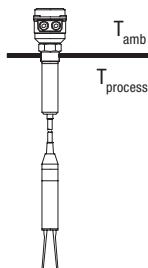
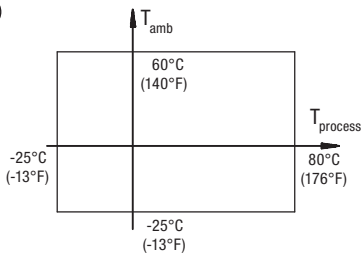

Sensibilità

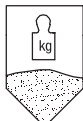

	B g/l	A g/l
VN 1000	50	150
VN 2000	20 / 5 ⁽¹⁾	75
VN 5000	50	150
VN 6000	20 / 5 ⁽¹⁾	75
1g/l = 0.06 lb/ft ³		

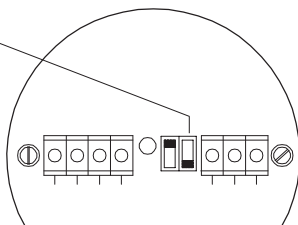

(1) Opzione: sensibilità d'intervento > 5 g/l (0.3 lb/ft³)

Tipo di materiale sfuso

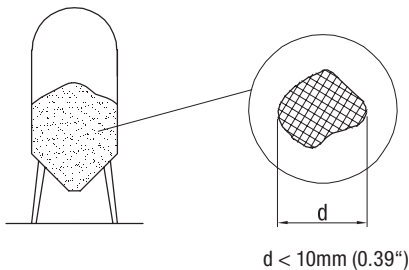

Installazione

VN 1020
VN 2020
VN 5020
VN 6020

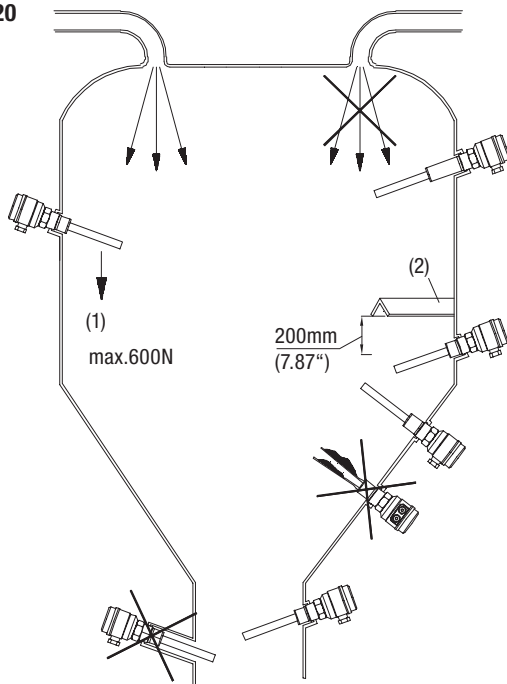

- (1) Carico mec. del sistema oscillante
- (2) Angolare in acciaio per forze meccaniche elevate

VN 1030
VN 2030
VN 5030
VN 6030

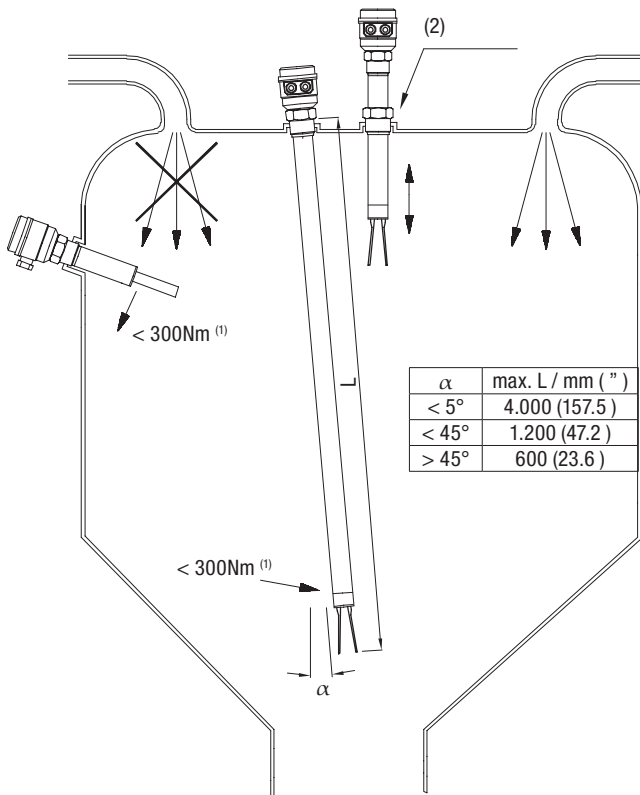

- (1) Carico mec. del sistema oscillante
(2) Manicotto sincronizzatore: vite di serraggio con 20Mn

VN 1050
VN 2050
VN 5050
VN 6050

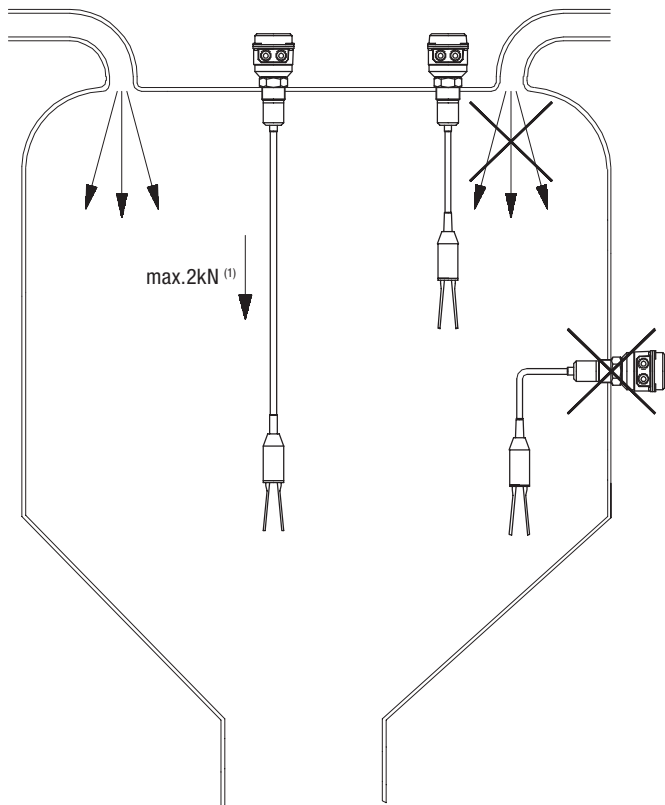

(1) Carico mec. del sistema oscillante

Montaggio

Fissaggio Filetto

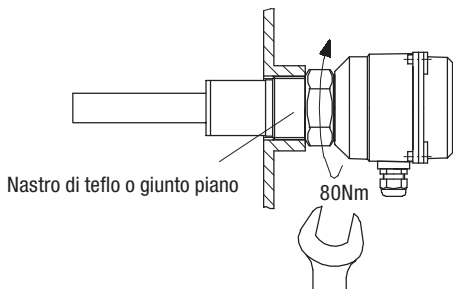

Fissaggio Flangia

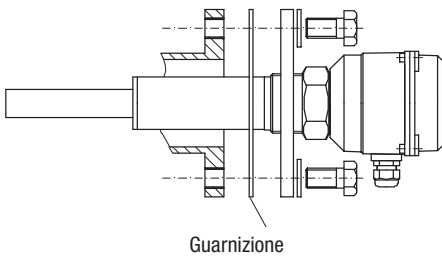

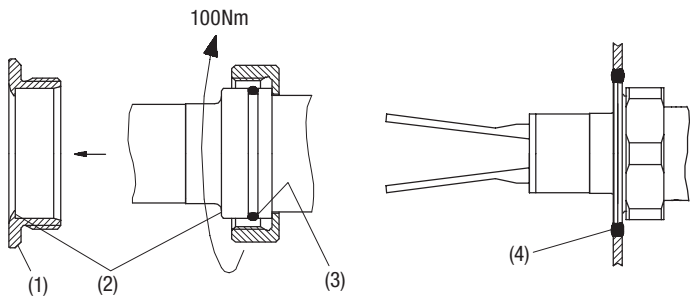

- (1) Manicotto a saldatura certificato prescritto
- (2) Metallo-placcatura non fissile
- (3) Anello di tenuta
- (4) Saldatura (osservare le norme igieniche)

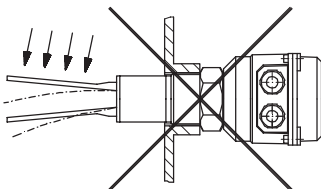
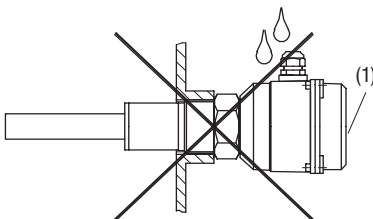
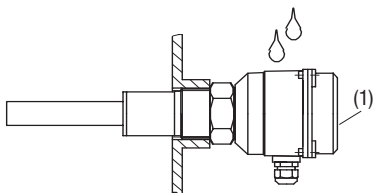

(1) Grado di protezione
IP 66 / IP67

Trattamento

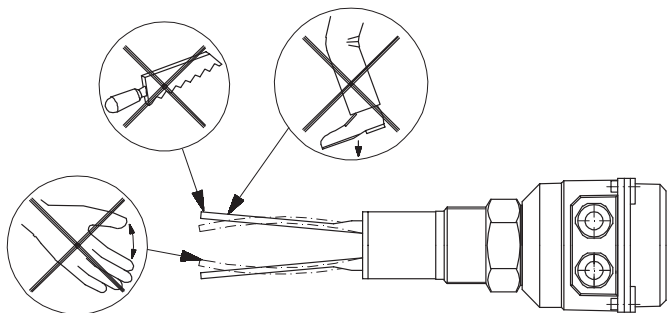

Opzione: Calotta di protezione contro le intemperie

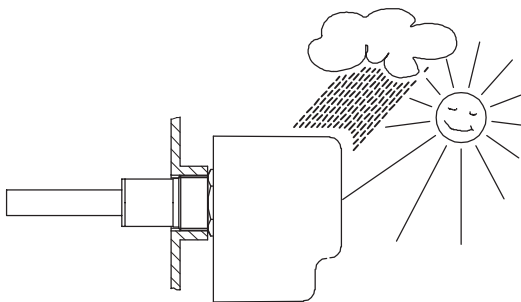

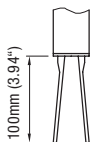

per Ex omologato solo per zona 22

Parti di ricambio

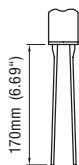

	CE / ATEX / IEC-Ex: VN 1020 VN 1030		CE / ATEX / IEC-Ex: VN 5020 VN 5030	
	CE: VN 1050	ATEX / IEC-Ex: VN 1050	CE: VN 5050	ATEX / IEC-Ex: VN 5050
<p>19...230V 50/60 Hz 19...55V DC</p>	pl100932	pl100120	pl100932	pl100120
<p>19...230V 50/60 Hz 19...55V DC</p>	pl100247	pl100052	pl100247	pl100052
<p>18...50V DC PNP</p>	pl100246	pl100123	pl100246	pl100123
<p>19...230V AC/DC</p>	pl100242	pl100122	pl100122	pl100172

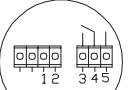

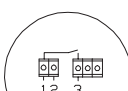
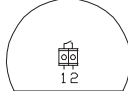
	CE / ATEX / IEC-Ex: VN 2020 VN 2030 CE: VN 2050	ATEX / IEC-Ex: VN 2050	CE / ATEX / IEC-Ex: VN 6020 VN 6030 CE: VN 6050	ATEX / IEC-Ex: VN 6050
 <p>19...230V 50/60 Hz 19...55V DC</p>	pl100930	pl100124	pl100930	pl100124
 <p>19...230V 50/60 Hz 19...55V DC</p>	pl100193	pl100050	pl100193	pl100050
 <p>18...50V DC PNP</p>	pl100176	pl100127	pl100176	pl100127
 <p>19...230V AC/DC</p>	pl100182	pl100126	pl100126	pl100126

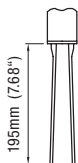

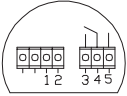
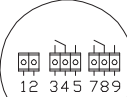
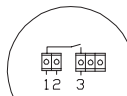
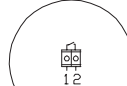
	CE / ATEX / IEC-Ex: VN 2020 VN 2030 CE: VN 2050	ATEX / IEC-Ex: VN 2050	CE / ATEX / IEC-Ex: VN 6020 VN 6030 CE: VN 6050	ATEX / IEC-Ex: VN 6050
 <p>19...230V 50/60 Hz 19...55V DC</p>	pl100931	pl100128	pl100931	pl100128
 <p>19...230V 50/60 Hz 19...55V DC</p>	pl100194	pl100051	pl100194	pl100051
 <p>18...50V DC PNP</p>	pl100173	pl100131	pl100173	pl100131
 <p>19...230V AC/DC</p>	pl100187	pl100130	pl100130	pl100130

Connessione elettrica

Tutti i moduli elettronici: Categoria di sovratensione II

Relè SPDT

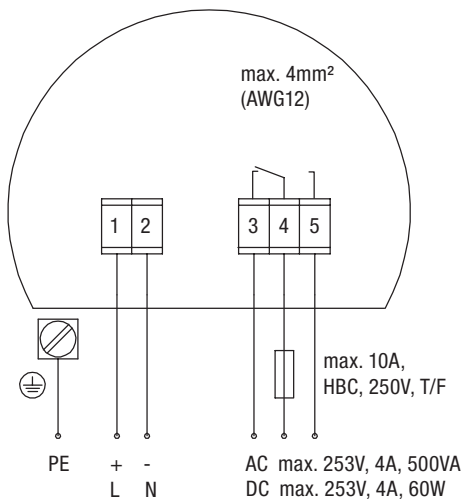

(1)

19...230V +10% ⁽³⁾ 50/60Hz 8VA

19... 50V +10% DC 1,5W

(2)

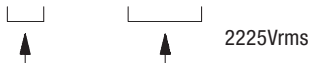

(1) Tensione di alimentazione

(2) Tensione isolante

(3) incluso 10% da EN 61010

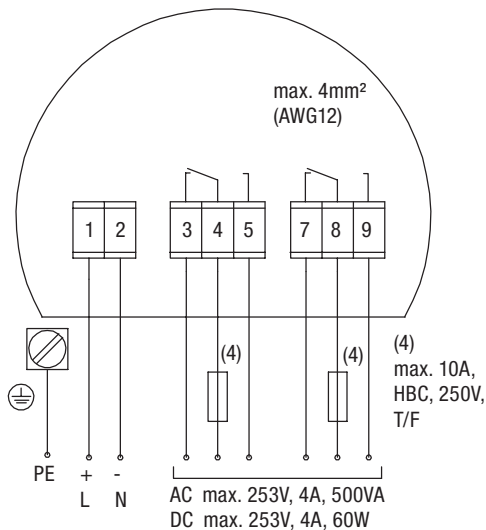

(1)

19...230V +10% ⁽³⁾ 50/60Hz 18VA

19... 50V +10% ⁽³⁾ DC 2W

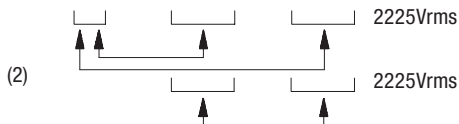

(1) Tensione di alimentazione

(2) Tensione isolante

(3) incluso 10% da EN 61010

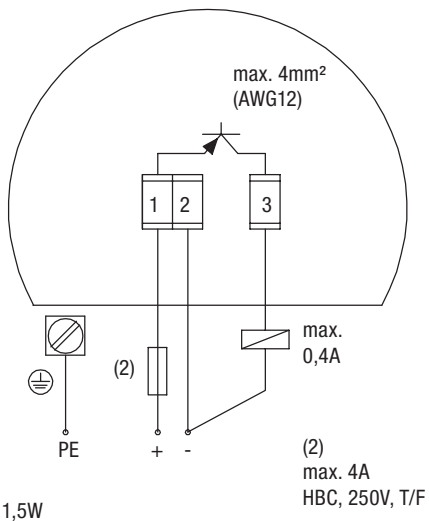

- (1) Tensione di alimentazione
(3) incluso 10% da EN 61010

2 fili senza contatto

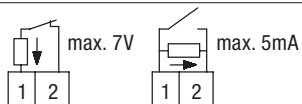
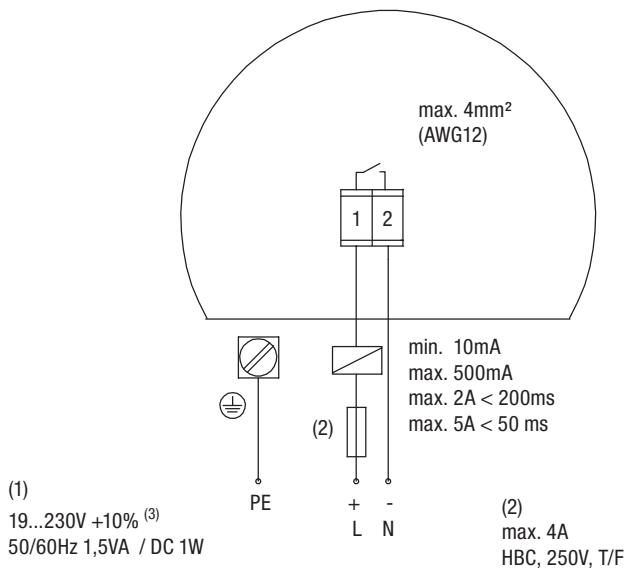

- (1) Tensione di alimentazione
(3) incluso 10% da EN 61010

Logica di commutazione

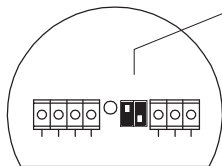

	FSL	FSH	
			(1)
			(2)
			(3)
			(4)
			(5)
			(1)
			(2)
			(3)
			(4)
			(5)

(1) = Relè SPDT

(2) = Relè DPDT

(3) = PNP

(4) = 2 fili senza contatto

(5) = LED segnale

Ritardo segnale (relè DPDT)

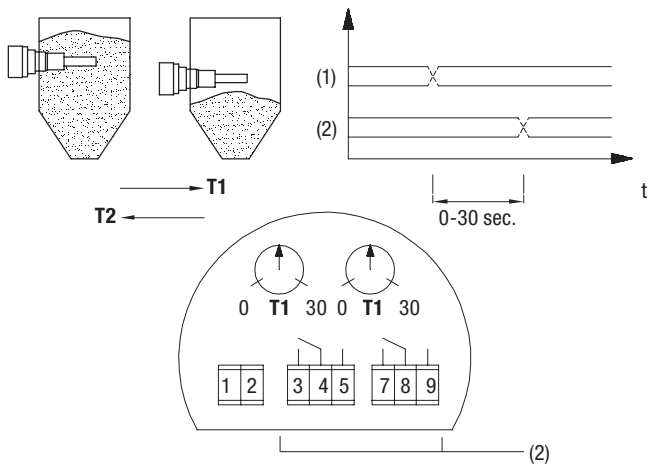

- (1) = livello di riempimento
(2) = uscita relè

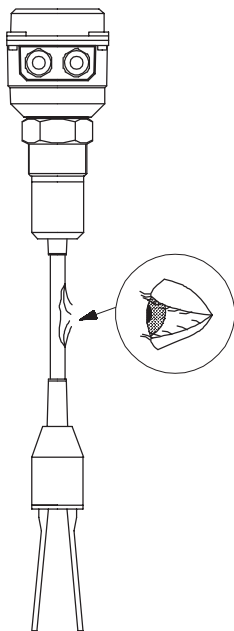
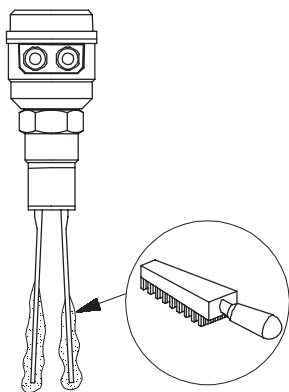

Montaggio

Scocca a gradini (scelta: listino prezzi, pos. 26)

VN 1020

VN 2020

VN 5020

VN 6020

VN 1030

VN 2030

VN 5030

VN 6030

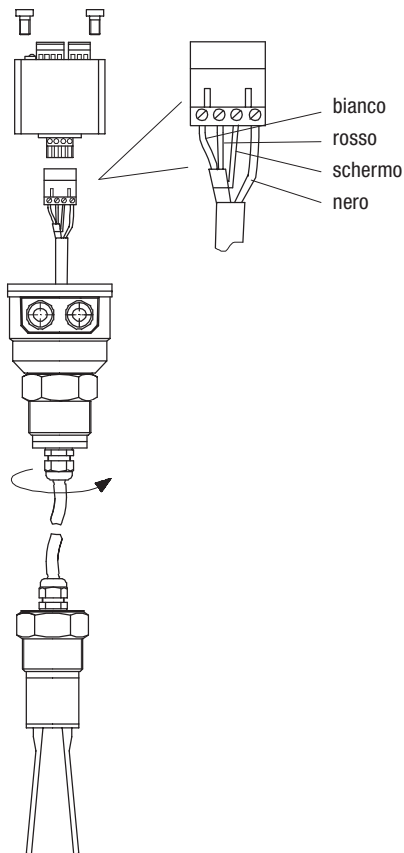

ATEX II 1D 1/2D + IEC-Ex t IIIC Da, Da/Db

Note

Pressione relativa consentita

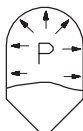

-0,2...+0,1bar
(-2.9...+1.45psi)

Limiti ammessi

VN 1020/1030
VN 2020/2030
VN 5020/5030
VN 6020/6030

VN 1020
VN 2020
VN 5020
VN 6020

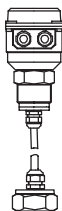

VN 1030
VN 2030
VN 5030
VN 6030



VN 1050
VN 2050
VN 5050
VN 6050



(1) 1D 2D
(2) Da Db
(3) 20 21

(1) 1D 1D
(2) Da Da
(3) 20 20

(1) Categoria (2) EPL (IEC-Ex) (3) Zona

Temperatura ambiente**temperatura max. superficie**

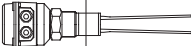
60°C (140°F) 	80°C (176°F)	120°C (248°F)
	90°C (194°F)	120°C (248°F)
	100°C (212°F)	120°C (248°F)
	110°C (230°F)	120°C (248°F)
	120°C (248°F)	120°C (248°F)
	130°C (266°F)	130°C (266°F)
	140°C (284°F)	140°C (284°F)
	150°C (302°F)	150°C (302°F)

I dati della tabella sono validi se la situazione d'installazione garantisce che la superficie della bussola filettata, in modalità di funzionamento normale, raggiunge una temperatura massima di 80°C (176°F).

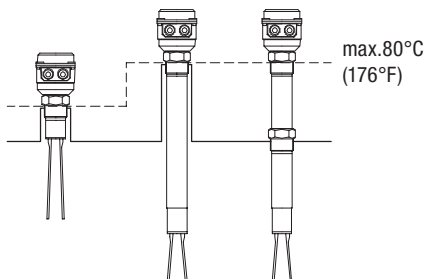

VN 1000

VN 2000

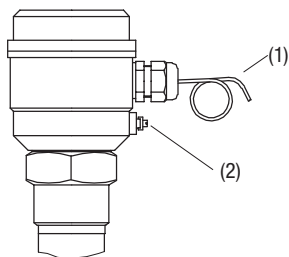

VN 5000

VN 6000

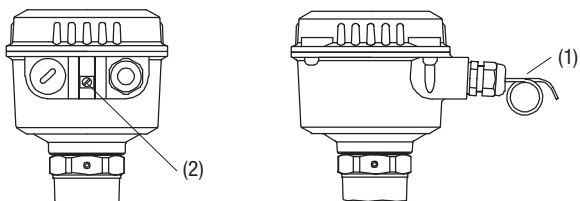

(1) prevedere uno scarico della trazione meccanica

(2) Collegare alla compensazione del potenziale

Per l'installazione e l'allacciamento si devono rispettare le norme vigenti nel Paese dell'installatore.

La messa in funzione va effettuata solo ad apparecchio chiuso.

L'apparecchio può essere aperto solo in assenza di tensione.

Prima dell'apertura, verificare che non siano presenti accumuli di polvere o materiali trascinati dalle palette.

Il montaggio dev'essere effettuato in modo tale da escludere la produzione di scintille, dovuta a procedimenti di percussione o strofinamento, tra il contenitore in alluminio e l'acciaio.

Se tutto l'apparecchio viene installato nell'area 20 (vale a dire senza muro divisorio tra area 20 e 21) la corrente di corto circuito non deve superare 10kA (osservare i dettagli della EN 60079-14)

Collegamento cavi:

L'esecuzione deve rispettare le normative del paese dove verrà installato l'apparecchio.

Punti di inserzione dei cavi non utilizzati devono essere chiusi con gli appositi otturatori.

Nei limiti del possibile utilizzare le parti fornite dal produttore.

Per quanto riguarda i collegamenti a vite per cavi forniti dal produttore è necessario prevedere uno scarico della tensione.

Il diametro dei cavi di collegamento deve essere idoneo all'area dei morsetti del collegamento a vite.

In caso venissero utilizzate parti diverse di quelle fornite dal produttore, assicurarsi che:

le parti siano dotate di omologazione, idonea all'omologazione dell'indicatore di livello (certificato e tipo di protezione).

La temperatura d'esercizio autorizzata deve corrispondere alla temperatura d'ambiente minima del rilevatore di livello e alla temperatura d'ambiente massima + 10 Kelvin del rilevatore di livello.

Le parti vanno montate in base alle indicazioni del libretto d'istruzioni fornito dal produttore.